

Giochi morbidi

Soft items

# FESTOPOLIS

A WORLD OF PLAYGROUNDS

[www.festopolis.com](http://www.festopolis.com)

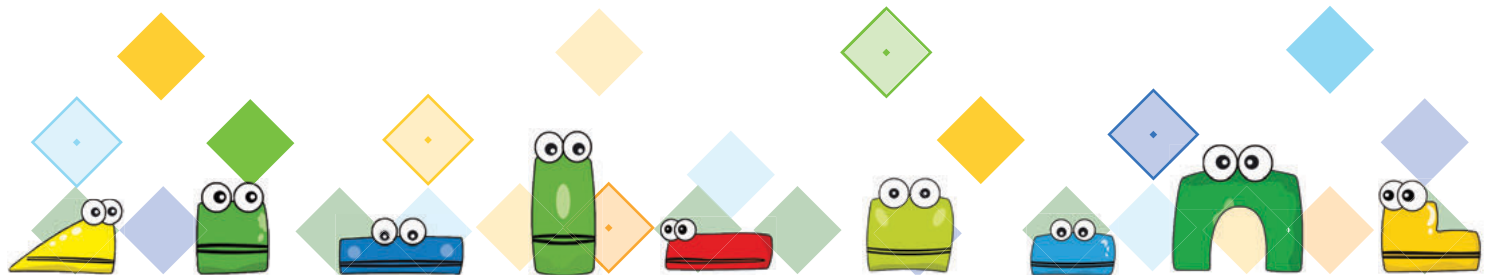

# GIOCHI MORBIDI

# OUR SOFT PLAY

- ◆ CERTIFICATI
- ◆ CONSEGNA RAPIDA
- ◆ ORDINE MINIMO 1 Pz
- ◆ CONSEGNA DIRETTA
- ◆ PERSONALIZZABILE
- ◆ ALTA QUALITA'

- ◆ CERTIFIED
- ◆ SHORT HANDLING TIME
- ◆ MOQ 1 UNIT
- ◆ DROP SHIPPING
- ◆ CUSTOMIZABLE
- ◆ HIGH QUALITY



N.B. PREZZI IVA E TRASPORTO ESCLUSI

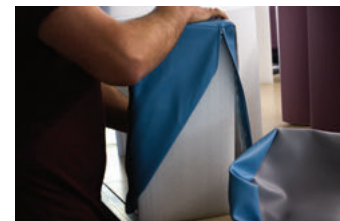

N.B. TRASPORTATION AND VAT NOT INCLUDED



## INSEGNARE AI BAMBINI A GATTONARE CON I NOSTRI PRODOTTI SOFT

QUESTO ARTICOLO E' UN OTTIMO STRUMENTO  
PER INSEGNARE AI BAMBINI A GATTONARE PIU' VELOCEMENTE  
E' ANCHE UN OTTIMO AIUTO PER I BAMBINI CHE HANNO  
PIU' DIFFICOLTA' A GATTONARE O HANNO UNO SVILUPPO FISICO PIU' LENTO.



**FEAS - 200703** <sup>+A</sup>



**FEAS - 200702** <sup>+A</sup>



## TEACH BABY TO CRAWL WITH SOFT PLAY EQUIPMENT

OUR PRODUCT IS A GREAT TOOL TO START TEACHING BABY  
TO CRAWL AT MUCH YOUNGER AGE.  
ALSO, IT IS A HUGE HELP FOR CHILDREN WHO STRUGGLE TO CRAWL  
OR HAVE SLOWER PHYSICAL DEVELOPMENT.

**FEAS - 201600**



600 X 410 X 850 mm

**5+ MESI**

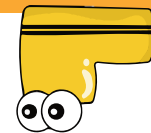

**FEAS - 200701** <sup>+A</sup>



510 X 510 X 690 mm



 **ARTICOLI PER GATTONARE**

 **SETS FOR CRAWLING**



**FEAS - 201601**



**FEAS - 201602 <sup>+A</sup>**



**10+ MESI**

**FEAS - 201608 <sup>+A</sup>**

**FEAS - 201604**



400X 400 X 650 mm

**A** ANTISCIVOLO

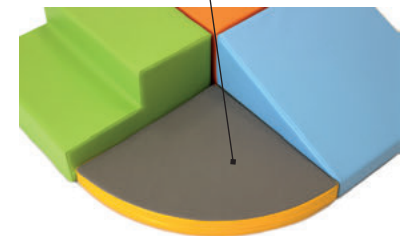

 **ARTICOLI PER GATTONARE**



**SETS FOR CRAWLING**

FEAS - 200601



400 X 400 X 650 mm

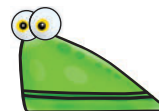
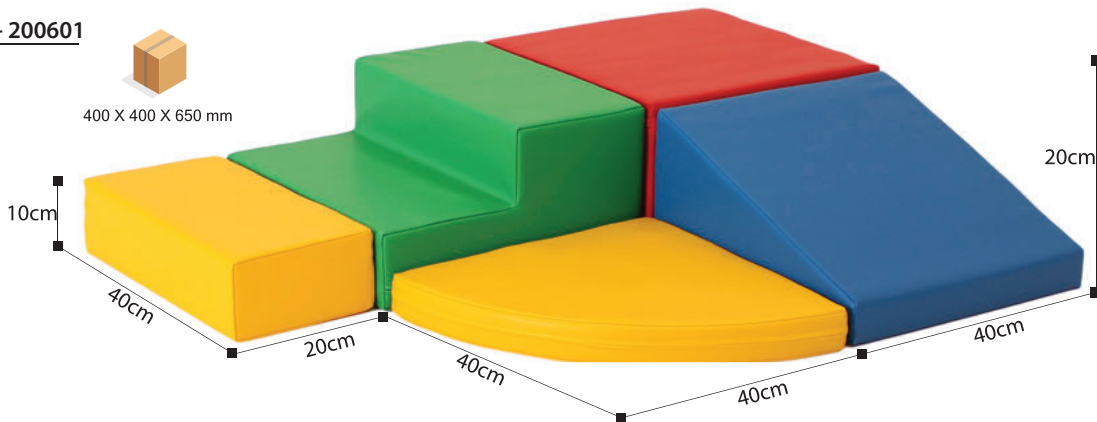

**10+ MESI**

FEAS - 200901



400 X 400 X 800 mm



FEAS - 200902 <sup>+</sup>A



400 X 400 X 800 mm



 **ARTICOLI PER GATTONARE**



**SETS FOR CRAWLING**



FEAS - 202601



400 X 400 X 650 mm

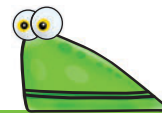
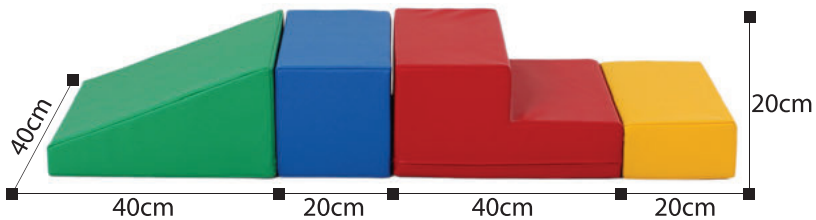

**10+ MESI**

FEAS - 202701



400 X 400 X 650 mm



FEAS - 202910



400 X 400 X 400mm

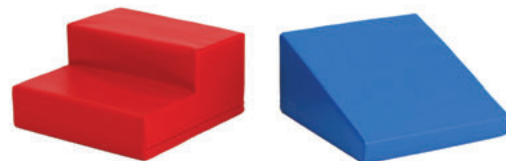



**FEAS - 200201**



400 X 400 X 800 mm



**2+ ANNI**

**FEAS - 200101**



400 X 400 X 650 mm



**FEAS - 201701**



400 X 400 X 650 mm



**FEAS - 201702**





# ARTICOLI PER ARRAMPICATA E COSTRUZIONI



# SETS FOR CLIMBING AND BUILDING



**FEAS - 200301**



600X 410 X 850 mm



**2.5+ ANNI**

LO SVILUPPO INTELLETTUALE DEL BAMBINO  
E' TANTO IMPORTANTE QUANTO QUELLO FISICO.  
QUINDI ABBIAMO DIVISO GLI ARTICOLI IN DIVERSE FORME  
PER PERMETTERE DI RICOSTRUIRLI, STIMOLANDO LA CREATIVITA',  
LA LOGICA E LA COORDINAZIONE.  
UN'OTTIMA FUNZIONE DI QUESTE COSTRUZIONI E' CHE  
GARANTISCONO IL MOVIMENTO. I BAMBINI SOLLEVANO I BLOCCHI,  
LI SPOSTANO, LI SOVRAPPONGONO... TUTTO CIO' PER PROMUOVERE  
IL LORO SVILUPPO FISICO.

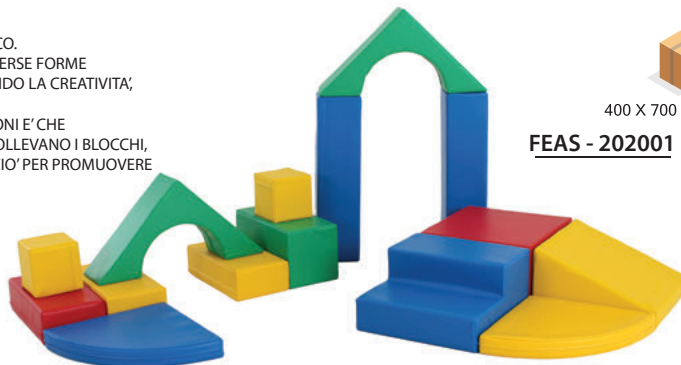

400 X 700 X 600 mm

**FEAS - 202001**

INTELLECTUAL DEVELOPMENT OF CHILDREN IS AS IMPORTANT  
AS PHYSICAL DEVELOPMENT  
SO WE HAVE SEPERATE SOFT PLAY EQUIPMENT CATEGORY  
WITH SETS FOR BUILDING, WHICH HELP TO DEVELOP CREATIVITY,  
LOGIC, COORDINATION AND PHYSICS.  
AND GREAT THING TO OUR BUILDING SETS  
IS THAT THEY GUARANTEE MOVEMENT. CHILDREN WILL LIFT,  
GRAB, DUCK, GET UP, WHICH WILL PROMOTE KIDS  
PHYSICAL DEVELOPMENT.





# ARTICOLI PER ARRAMPICATA E COSTRUZIONI



# SETS FOR CLIMBING AND BUILDING



FEAS - 202102



500 X 500 X 1000 mm



**2.5+ ANNI**

FEAS - 202101



500 X 500 X 1000 mm

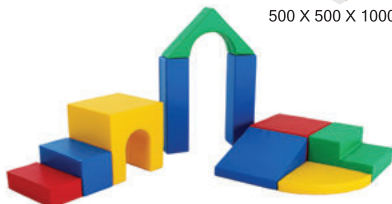

FEAS - 202103



500 X 500 X 1000 mm



FEAS - 202104



500 X 500 X 1000 mm





# ARTICOLI PER ARRAMPICATA E COSTRUZIONI



# SETS FOR CLIMBING AND BUILDING



FEAS - 202401



600X 410 X 850 mm

FEAS - 201501



600 X 410 X 850 mm



**2.5+ ANNI**





# ARTICOLI PER ARRAMPICATA E SCIVOLATA



# SETS FOR CLIMBING AND TURNING



**FEAS - 203002**  
89,00 €



400X 400 X 650 mm

**FEAS - 203001**



**FEAS - 203004** <sup>+</sup>A

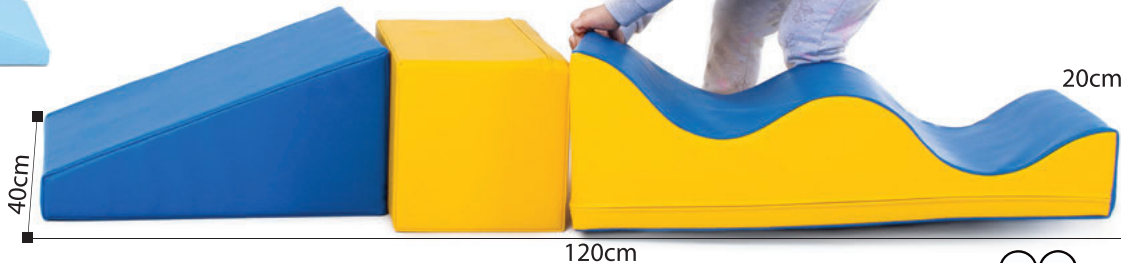

**ANTISCIVOLO**



**FEAS - 202802** <sup>+</sup>A



400X 400 X 800 mm

**FEAS - 202801**



**3+ ANNI**



# ARTICOLI PER ARRAMPICATA E SCIVOLATA



# SETS FOR CLIMBING AND TURNING



FEAS - 203301



600 X 410 X 850 mm

FEAS - 203101



400 X 400 X 800 mm



FEAS - 203303

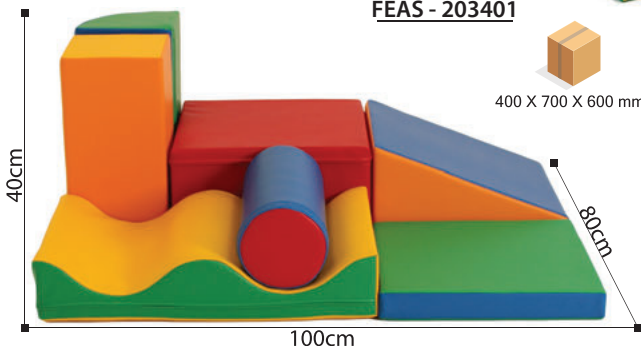

FEAS - 203401



400 X 700 X 600 mm

FEAS - 203201



400 X 400 X 650 mm



**3+ ANNI**





# ARTICOLI PER ATTIVITA' FISICA

OGGI MOLTI BAMBINI HANNO PROBLEMI DI PESO A CAUSA DELLA MANCANZA DI MOVIMENTO  
NOI ABBIAMO IDEATO ALCUNI ARTICOLI PER AIUTARE A RISOLVERE QUESTO PROBLEMA CRESCENTE.  
IN QUESTA CATEGORIA CI SONO ARTICOLI CON FORME PIU' GRANDI PER AGEVOLARE UNO STILE DI VITA PIU' ATTIVO:  
CORSE, SALTI, ARRAMPICATE  
QUESTI ARTICOLI PERMETTONO DI CREARE DIVERTENTI ATTIVITA' PER BAMBINI COME CORSE, PERCORSI AD OSTACOLI, ETC.



# SETS FOR ACTIVITIES

NOWADAYS, MORE AND MORE CHILDREN HAVE WEIGHT ISSUES DUE TO LACK OF MOVEMENT.  
TEAM HAS CREATED AND OFFER SOFT PLAY EQUIPMENT TO HELP SOLVE THIS INCREASING PROBLEM.  
IN THIS CATEGORY WE HAVE SETS WITH LARGER SHAPES FOR MORE ACTIVE LIFESTYLE - RUNNING, JUMPING, CRAWLING AND ROMPING.  
THESE SETS ALLOW TO CREATE FUN ACTIVITIES FOR KIDS LIKE RELAY RACES, OBSTACLE COURSES ETC.



FEAS - 200106 (+A)

FEAS - 200116 (+A)



FEAS - 200108 (+A)



FEAS - 201617



FEAS - 200102



500 X 500 X 1000 mm

50cm

200cm



3+ ANNI



# ARTICOLI PER ATTIVITA' FISICA



# SETS FOR ACTIVITIES

ARTICOLI OTTIMI PER SPORT, AREE GIOCO E PER CASA.

THESE ARE GREAT ATTRIBUTES FOR SPORTING CLASSES, PLAY ZONES AND HOME.

FEAS - 200118



500 X 500 X 1000 mm

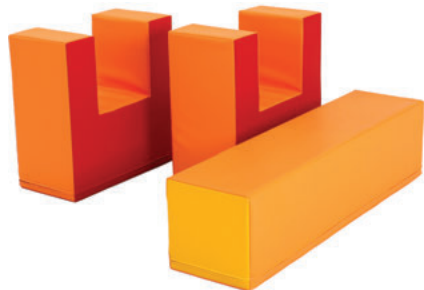
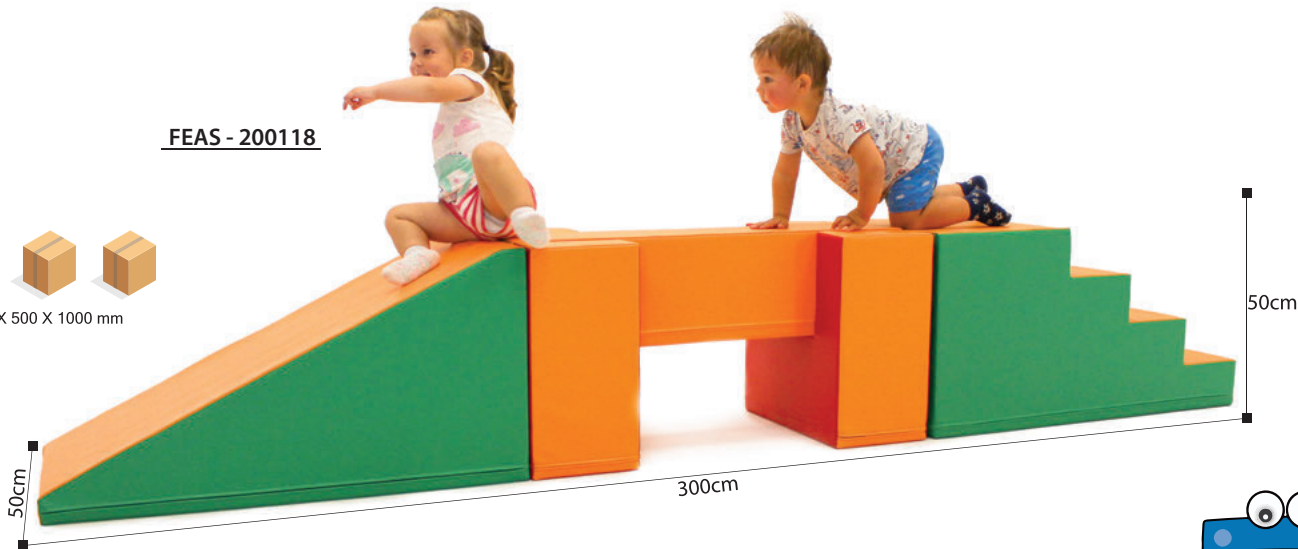

FEAS - 200119



500 X 500 X 1000 mm



**3+ ANNI**



# ARTICOLI PER ATTIVITA' FISICA



# SETS FOR ACTIVITIES



**FEAS - 207001**



1200 X 800 X 1000 mm



**FEAS - 201201**



1200 X 800 X 2000 mm



**FEAS - 201901**



1200 X 800 X 1000 mm

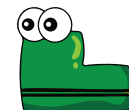

**6+ ANNI**

# ARTICOLI PER ATTIVITA' FISICA



# SETS FOR ACTIVITIES



FEAS - 2001



FEAS - 2002



FEAS - 2003

DIFFERENTI ARTICOLI E COLORI  
PER ADATTARSI SIA AI BAMBINI  
CHE ALLE BAMBINE  
I NOSTRI DONDOLI NON SONO SOLO DIVERTENTI,  
MA ANCHE UTILI: FACILITANO LA CONOSCENZA  
DELLO SPAZIO, L'ATTIVITA' FISICA  
E L'IMMAGINAZIONE  
IDEALE PER USO DOMESTICO E USO PUBBLICO  
(ASILI, SCUOLE, AREE GIOCO ETC.)

FEAS - 2004



260 X 460 X 910 mm



MADE IN DIFFERENT DESIGNS AND  
COLOURS TO SUIT BOTH, BOYS AND  
GIRLS.

OUR ROCKERS ARE NOT ONLY FUN BUT  
BENEFICIAL AS WELL. THEY FACILITATE  
SPATIAL AWARENESS, PHYSICAL  
ACTIVITY AND IMAGINATIVE PLAY.  
IDEAL FOR USE AT HOME, IN KINDER-  
GARTENS, SCHOOLS, PLAY AREAS,  
NURSERIES ETC.

FEAS - 2005

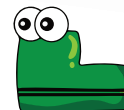

**6+ ANNI**





# DONDOLI BANANA



FEAS - 20016



250 X 500 X 1150 mm



# BANANA ROCKERS



FEAS - 2010



250 X 500 X 1150 mm

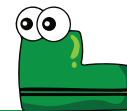

**6+ ANNI**



**PISCINE DI PALLINE**  
**OTTIME PER BAMBINI DI OGNI ETA',**  
**ANCHE NEONATI**



**BALL PITS**  
**GREAT FOR CHILDREN IN ANY AGE,**  
**EVEN BABIES**



LE NOSTRE PISCINE DI PALLINE SONO DIVERTENTI, ATTRAENTI E DI ALTA QUALITA'. DISPONIBILI IN DIVERSE MISURE, COLORI E COMBINAZIONI DI ACCESSORI. GLI ACCESSORI SONO: BASE, GRADINI, SCIVOLI

BALL PITS ARE FUN ATTRACTIVE AND HIGH QUALITY. AVAILABLE IN DIFFERENT SIZES, COLOUR AND ACCESSORY COMBINATIONS. ACCESSORIES INCLUDE MATS, STEPS AND SLIDES.

**FEAS - PP2017**



1200 X 500 X 430 mm

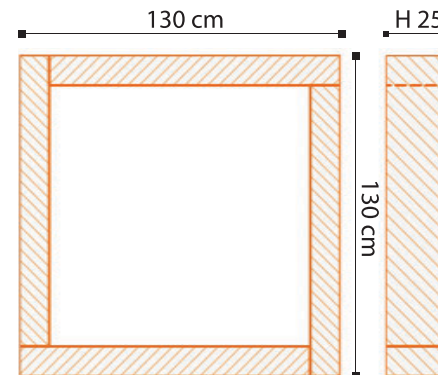

**FEAS - PP2016**



**FEAS - PP2015**



**FEAS - PP2014**



## PISCINE DI PALLINE

LE NOSTRE PISCINE DI PALLINE SONO PROGETTATE PER AREE GIOCO, SCUOLE, ASILI, SALE FESTA E PER QUALSIASI ALTRO POSTO DOVE SONO RICHIESTE ATTIVITA' LUDICHE PER BAMBINI.

**FEAS - PP2013**

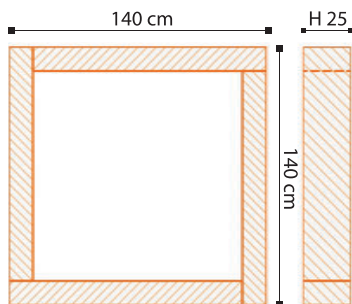

## BALL PITS

OUR BALL PITS ARE MADE FOR SOFT PLAY AREAS, SCHOOLS, KINDERGARTENS, PARTY ROOMS, NURSERIES AND ANYWHERE ELSE WHERE THE FUN ACTIVITIES FOR KIDS ARE REQUIRED.

**FEAS - PP2011**

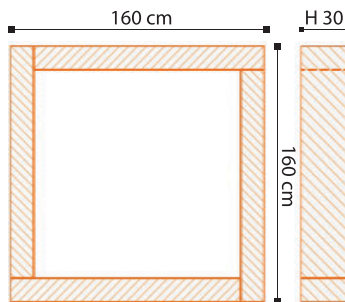

**FEAS - PP2012**

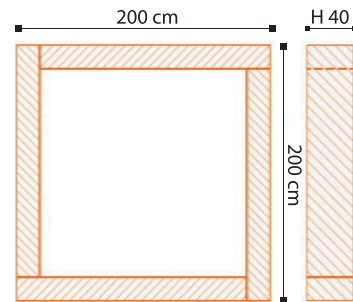



# COSTRUZIONI



# CONSTRUCTOR

## IN SET:



X 4



X 4



X 4

FEAS - 20210



500 X 500 X 1000 mm

QUESTO SET DI COSTRUZIONI E' BASATO SU 3 FORME PRINCIPALI, LE QUALI SI POSSONO CONNETTERE PER COSTRUIRE UN OGGETTO IN VARI E DIVERSI MODI  
CI SONO MOLTISSIME E DIVERSE POSSIBILITA' DI COMBINARE LE FORME: I BAMBINI POSSONO COSTRUIRE SEDIE, TAVOLI, MURI, ETC.



THIS IS A CONSTRUCTOR SET THAT IS BASED ON THREE MAIN SHAPES, WHICH CAN BE CONNECTED TO BUILD AN OBJECT IN SEVERAL DIFFERENT WAYS.

THERE ARE A LOT OF VARIATIONS HOW TO COMBINE THE SHAPES - CHILDREN CAN BUILD A PLAY CHAIR OR TABLE, A WALL, WHICH THEN CAN BE TEARED DOWN ETC.

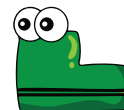

**6+ ANNI**



## LETTINI

PIU' RIPOSO, MIGLIOR UMORE.  
 ASSICURATI CHE I BAMBINI ABBIANO LE ORE DI RIPOSO CHE NECESSITANO OGNI GIORNO.  
 FARE UN PISOLINO IN QUESTI LETTI RICARICHERA' LA MENTE E IL CORPO DEI BAMBINI.  
 QUESTO COMODO LETTINO GARANTISCE LA PRIVACY E LA SICUREZZA DURANTE IL RIPOSO  
 E SI TRASFORMA IN UNA STRUTTURA DA GIOCO QUANDO IL RIPOSO E' FINITO.



**FEAS - 200601**



1300 x 750 x 260 mm

**A** ANTISCIVOLO

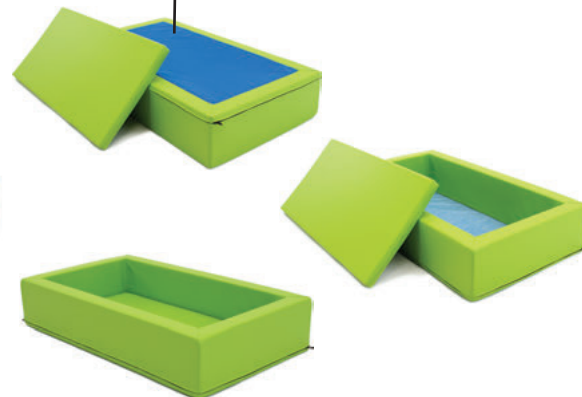

## BEDS

MORE SLEEP, BETTER MOOD.  
 MAKE SURE KIDS GET THE HOURS OF REST THAT THEY NEED EVERY DAY.  
 TAKING A NAP IN BED WILL RECHARGE KIDS MIND AND BODY.  
 THIS COSY BED GIVES PRIVACY AND SECURITY DURING A SLEEP  
 TIME AND CAN TRANSFER TO PERSONAL PLAYGROUND WHEN THE NAP IS OVER.





# PISCINA COMBINATA POOL WITH CLIMB

PISCINA COMBINATA CON ARRAMPICATA,  
GRADINI DI SALITA, SCIVOLO, VASCA PALLINE  
E PANCA PER I GENITORI.  
TUTT IN UN UNICO GIOCO.

COMBINED POOL WITH CLIMB, STEPS, SLIDE,  
BALL POOL AND BENCH FOR PARENTS.  
ALL IN ONE ITEM.

**FEPP - 004**

*\*including balls*



COMBINAZIONI DI COLORI A SCELTA  
COLOR COMBINATIONS OF YOUR CHOICE



CONSEGNA DIRETTA  
DROP SHIPPING



# COSTRUZIONI CONSTRUCTOR

REALIZZA LE COSTRUZIONI DEI TUOI SOGNI UTILIZZANDO I NOSTRI BLOCCHI MULTICOLOR GIGANTI.  
LEGGERI E SOFFICI, 100% RICICLABILI, SONO ADATTI AI BAMBINI DI TUTTE LE ETÀ E FACILITANO  
LO SVILUPPO DELL'INTELLIGENZA, DELLA COORDINAZIONE MANO-OCCHIO E DELLA SOCIALIZZAZIONE.  
IMPERMEABILI, RESISTENTI AGLI OLI, ACIDI, SOLVENTI E AL CALORE.

MAKE YOUR OWN CONSTRUCTION USING OUR GIANT MULTICOLOR BLOCKS. LIGHT AND SOFT,  
100% ENVIRONMENTALLY FRIENDLY RAW MATERIALS, SUITABLE FOR ALL CHILDREN AND GOOD FOR KIDS  
FOR DEVELOPING THEIR INTELLIGENCE AND TRAIN THEIR HAND-EYE COORDINATION.  
WATERPROOF, RESISTANT TO OIL, ACID AND VARIOUS CHEMICAL SOLVENT, HEAT-RESISTANCE.

LA CONFEZIONE E' COMPOSTA DA  
40 BLOCCHI CM 30 X 15 X H 17,5 &  
16 BLOCCHI CM 15 X 15 X H 17,5.

THE SET IS COMPOSED BY  
40 PIECES CM 30 X 15 X H 17,5 &  
16 PIECES CM 15 X 15 X H 17,5.

**FEGP - 105**



910 x 610 x 710 mm



 **COSTRUISCI LA TUA CASA**

UTILIZZA LE 84 MATTONELLE IN GOMMAPIUMA  
PER COSTRUIRE LA TUA CASA...  
SARA' UN GIOCO UNICO, INNOVATIVO E SUPER DIVERTENTE.



 **BUILD YOUR OWN HOUSE**

USE THE 84 FOAM RUBBER BRICKS TO BUILD YOUR OWN HOUSE...  
IT WILL BE A UNIQUE,  
NEW AND EXTREMELY FUN GAME.



**FEGI - 008**



CONSEGNA DIRETTA  
DROP SHIPPING

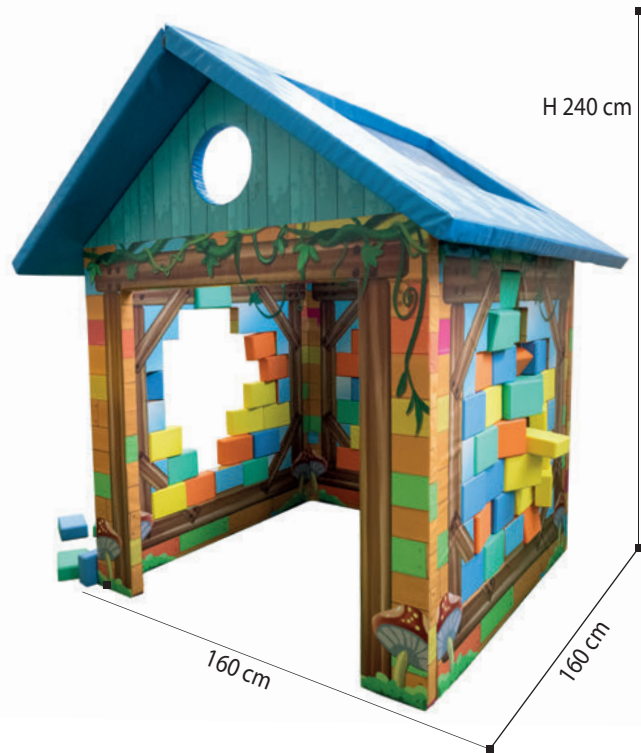

# FESTOPOLIS



A WORLD OF PLAYGROUNDS

[www.festopolis.com](http://www.festopolis.com)

**FESTOPOLIS s.r.l**  
ZONA INDUSTRIALE s.n.c  
66050 DOGLIOLA (CH) - ITALY

Tel. +39 0873 45 44 30 fax. +39 0873 45 44 30  
**Responsabile vendite:** + 39 347 64 35 294 / + 39 338 96 01 966  
**Responsabile Import-export:** +39 333 41 48 738  
E-mail: [festopolis@festopolis.com](mailto:festopolis@festopolis.com) / [import-export@festopolis.com](mailto:import-export@festopolis.com)  
Sito web: [www.festopolis.com](http://www.festopolis.com)

 **Festopolis Giochi**  **festopolis\_giochi**

