

1967

GPS

L'arte della decorazione





Caro amico

Spero che Lei concordi con noi nel considerare il n.s settore sicuramente divisibile in due grandi categorie: quelli che esercitano da lunghi anni il "mestiere" e chi si accinge era ad "iniziarlo" con impegno. Agli uni ed agli altri offriamo quale riconoscente amicizia questo prezioso catalogo: sarà una guida sicura per chi desidera associare al proprio lavoro l'oggettistica decorativa in gesso e in agglomerato di marmo e resina, proponendo la consultazione altresì al pubblico direttamente interessato, che spesso, al di là delle incertezze, di carattere economico, vive quelle di ordine psicologico: il timore di sbagliare o di non scegliere bene.

Il n.s catalogo sarà certamente consigliere fidato su quanto il più significativo e tradizionale esiste nel settore, affiancando alla Vs. esperienza la nostra antica tradizione.

Le nostre decorazioni in gesso e agglomerato di marmo e resina sono patrimonio di antiche strutture, filtrato "attraverso le composizioni del nostro tempo".

Sfogli dunque "caro amico" questo catalogo con la certezza di trovare qualche cosa che la interessa oggi o la potrà interessare domani.

Dopo averlo consultato lo conservi gelosamente, la GPS sarà così il pegno di una amicizia che continua nel tempo.

GPS



Dear Sir,

we hope you agree with us in consider our sector certainly divisible into two large grades: those who carry on a trade for many years and those who are about to start it now with care.

To the former and to the latter we offer as grateful friendship this valuable catalogue: it will be a sure guide for those who wish to associate to his own job the ornamental articles in plaster and the marble and resin agglomerate, proposing also the consultation to the public directly interested, who usually, beyond some uncertainties, of economic kind, has also the doubts of psychological kind, that is the fear to mistake or to not choose properly..

Our catalogue will certainly be your reliable adviser on what the most significant and traditional exists in our sector, supporting your experience with our old tradition.

Our plaster and marble resin agglomerate decorations are heritage of old structures, filtered "through compositions of our time".

Therefore, DEAR FRIEND. skim throught this catalogue sure to find out something you are interested in now or you will be interested in tomorrow.

After you have consulted it, keep it with loving care, the GPS will be so the pledge of a friendship which continues in the time.

GPS



Lieber Freund

Sicher sind Sie mit uns einer Meinung das unser Sektor in zwei grosse Kategorien aufzuteilen ist,

einmal Unternehmen die schon seit langen Jahren im Gescheft sind and zum anderen neue Unternehmen die sich mit grossem Einsatz einfuehren wollen.

Den einen wie den anderen bietenwir diesen wertvolten Katalog an, eine sichere Fuehrung fuer alle diejenigen die ihre arbeit verbinden wollen mit dekorativen Objekten aus Gips oder Sinterstoff aus Marmor und Kunstharz.

Dieses Katalog dient ausserdem als Ratgeber fuer ein direkt interessiertes publihum, welches jedoch noch unentschlossen ist, einmal aus wirtschaftlichen Motiven oder zum anderen aus psychologischen Gruenden: wie z.B.angst vor einer Fehlentscheidung.

Unser Katalog ist eine sichere Fuehrung fuer alles was der sector traditionelles and bedeutungsvolles zu bieten hat, im vertrauen auf Ihre Berufserfahrung and unsere antike tradition.

Unsere dekorationen aus Gips oder Sinterstoff aus Marmor und Kunstharz sind das Erbe der antiken Strukturen gefiltert "durch die Kompositionen der heutigen Zeit".

Also "lieber freund" schauen Sie sich diesen Katalog an und mit Sicherheit finden Sie etwas was Sie heute interessiert oder morgen interessieren koennte.

Nach der Beratung den Katalog gut aufbewahren: Der GPS wird somit der Pfand fuer eine lange andauernde Freundschaft

die GPS



Cher ami,

J'espere que vous serez d'accord avec nous en considérant notre secteur divisible en deux grandes catégories: ceux qui exercent depuis de nombreuses années la "profession" et ceux qui s'apprêtent maintenant à "commercer à l'exercer" avec zèle.

Aux uns et aux autres nous offrons, en gage de notre amitié reconnaissante ce precieux catalogue: ce sera un guide sûr pour ceux qui désirent ajouter à leur travailler objets décoratifs en plâtre et les agglomèrès en marbre et en résine, en proposant en outre la consultation au public directement intéressè, qui, souvent au delà des incertitudes d'ordre économique, vit dans l'incertitude d'ordre économique, vit dans l'incertitude d'ordre psychologique: la crainte de se tromper dans son choix.

Notre catalogue sera certainement un conseiller sûr, puor tout ce qui est significatif et traditionnel dans le secteur, en ajoutant à votre expérience notre tradition antique.

Nos décoration en plâtre et agglomèrès en marbre et en résine sont le patrimoine de structures antiques, filtrè "a travers les compositions de notre temps"

GPS.

Cornici



S 13

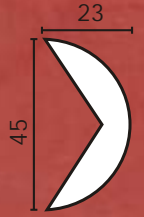

S 168

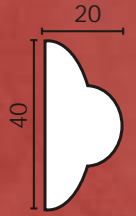

S 6



S 166



S 4



S 2

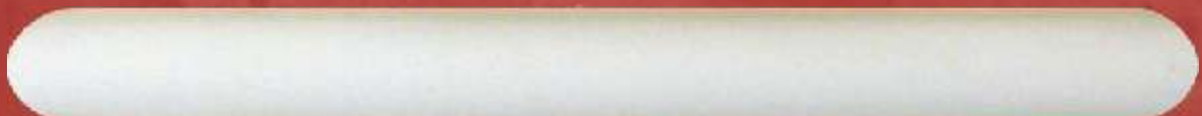

S 154

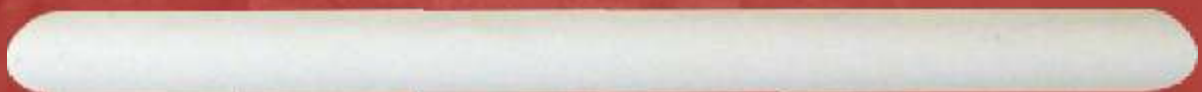
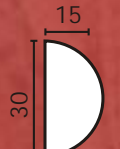

S 233



S 163



S 295



Cornici

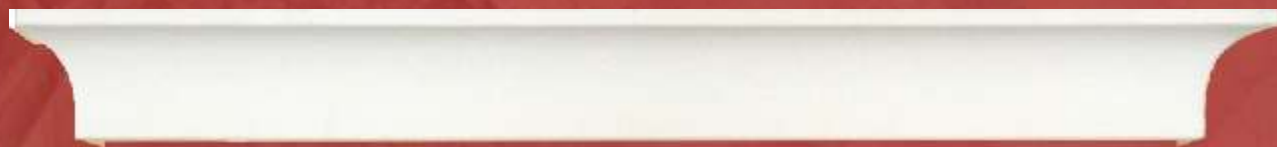

S 20

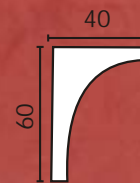

S 165

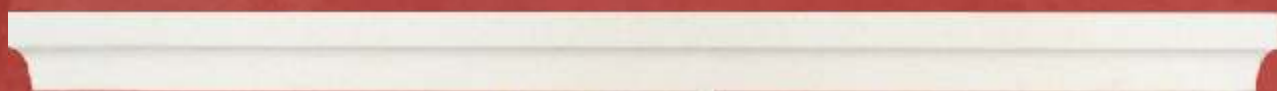
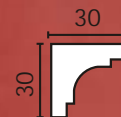

S 167

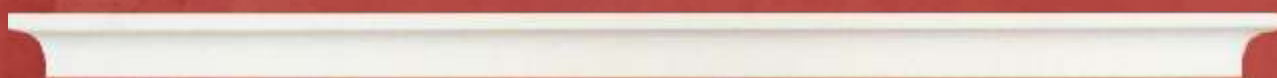

S 270

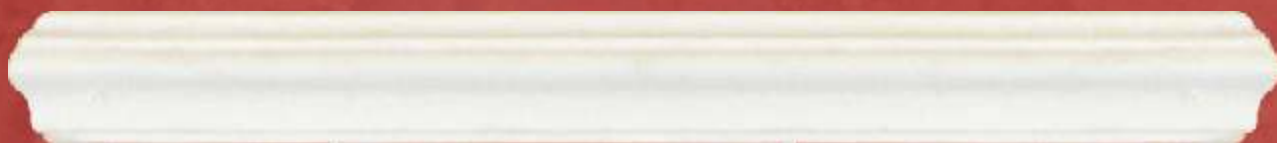
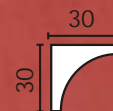

S 3



S 11



S 234

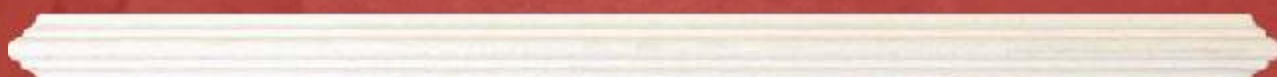

S 5



S 1

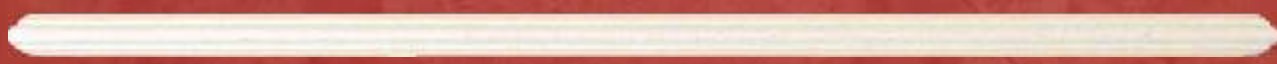

S 164



Cornici

S 170

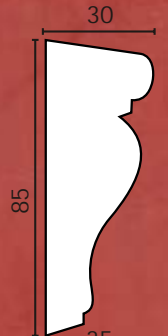

S 24



S 285

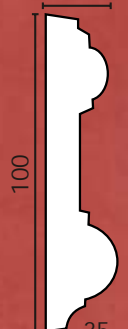

S 19

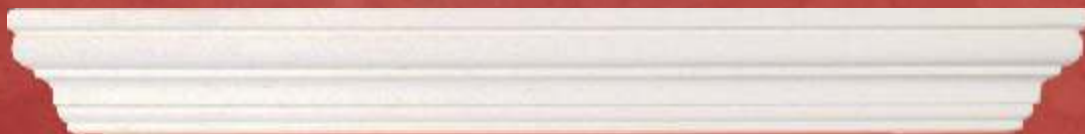

S 277

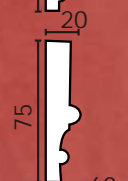

S 78

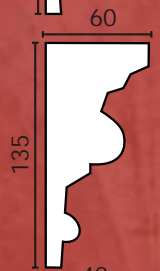

S 77



S 25



Cornici



Cornici

S 65

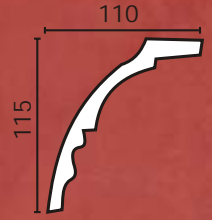

S 40

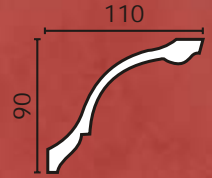

S 275

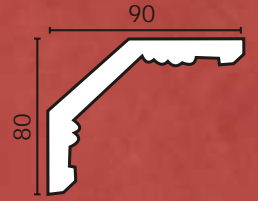

S 140

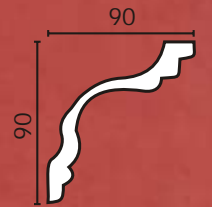

S 35

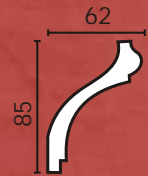

S 177



S 173



S 23



S 50

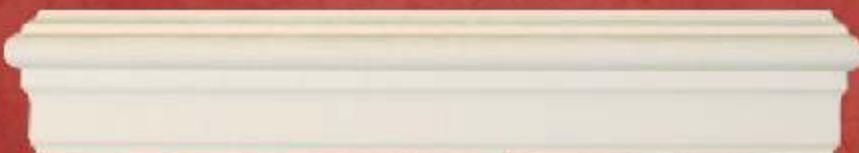

Cornici



S 184

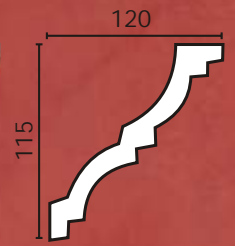

S 183

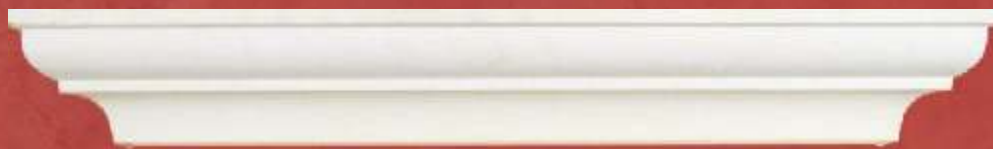
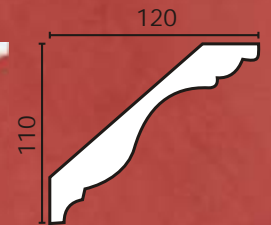

S 171

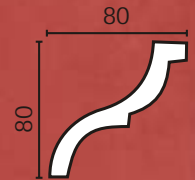

S 39



S 286



S 149

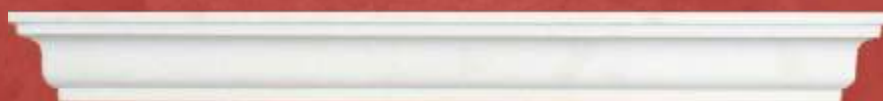

S 16

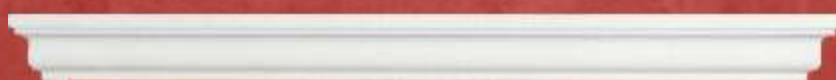

S 148



S 297



Cornici



S 21

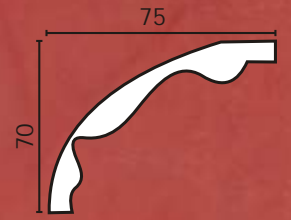

S 59

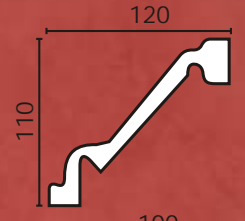

S 219

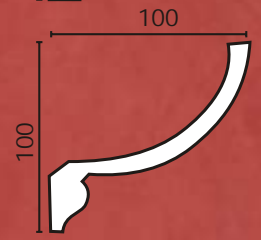

S 64

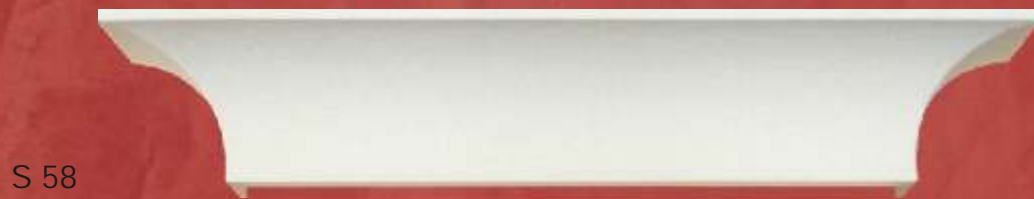
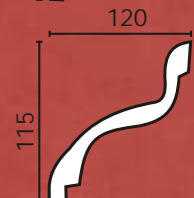

S 58

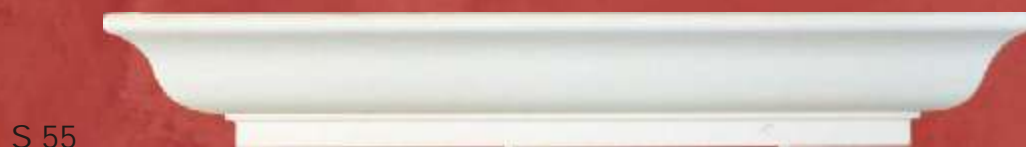
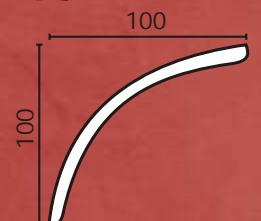

S 55

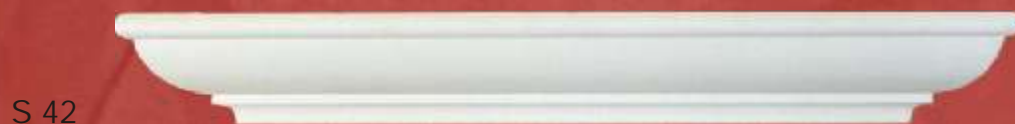
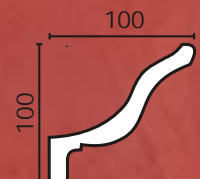

S 42



S 41

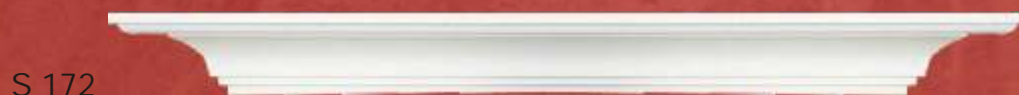

S 172

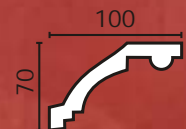

S 274

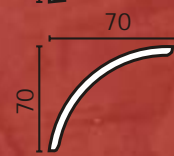

Cornici



S 145

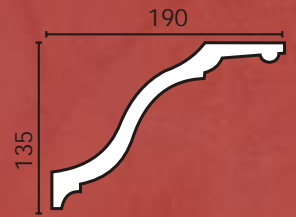

S 70

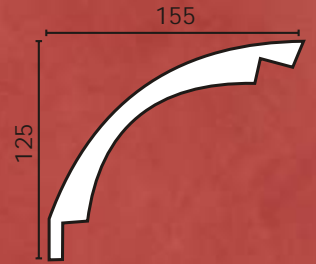

S 88

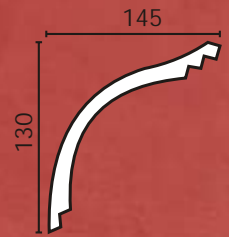

S 185

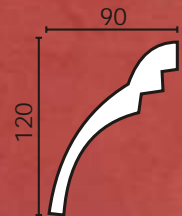

S 49

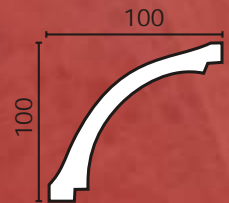

S 176

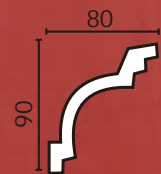

S 257

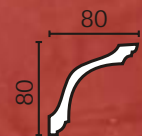

Cornici



S 101

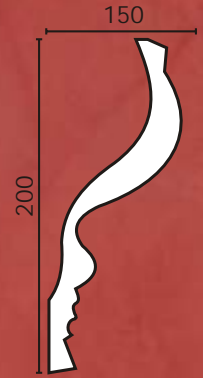

S 85

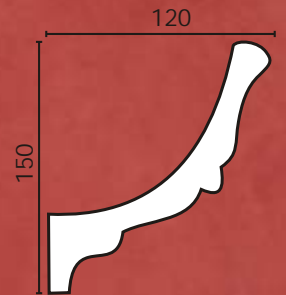

S 195

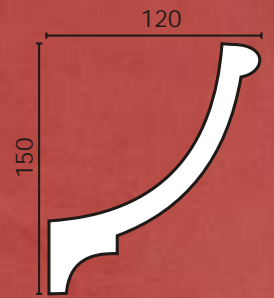

S 144

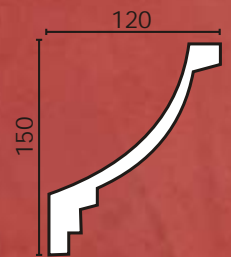

S 156

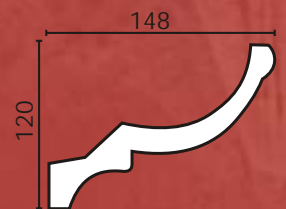

S 199

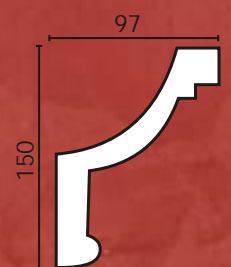

Cornici

S 92

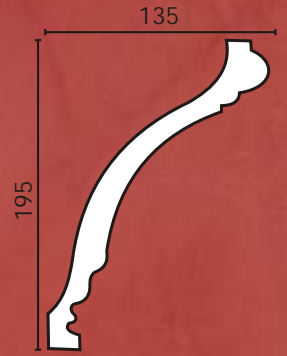

S 89



S 296

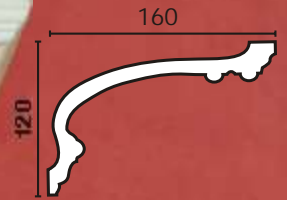

S 191

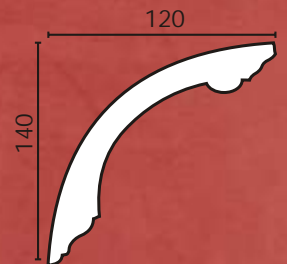

S 241

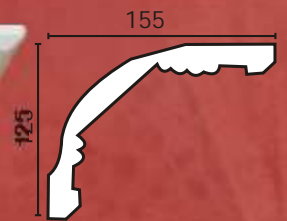

S 71

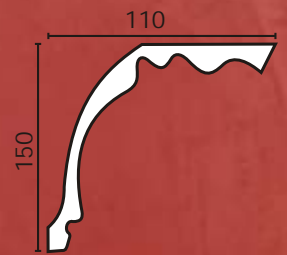

S 193

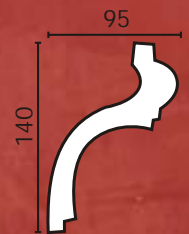

Cornici



S 252

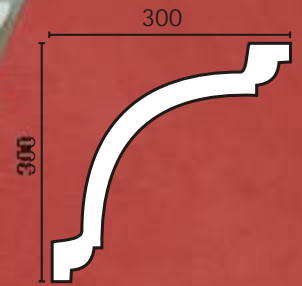

S 251

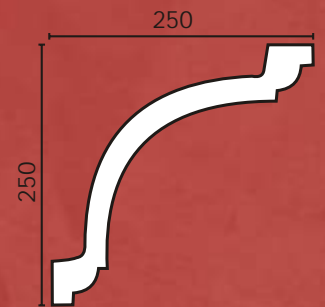

S 96

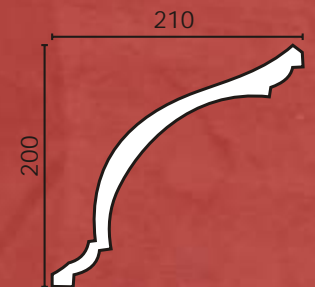

S 249

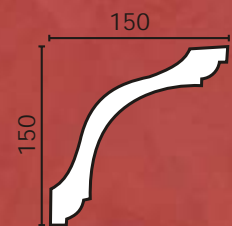

S 248

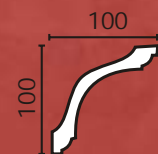

S 162



Cornici

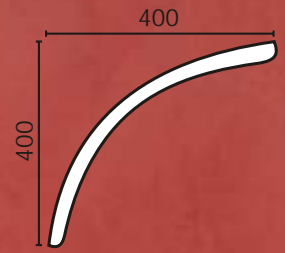
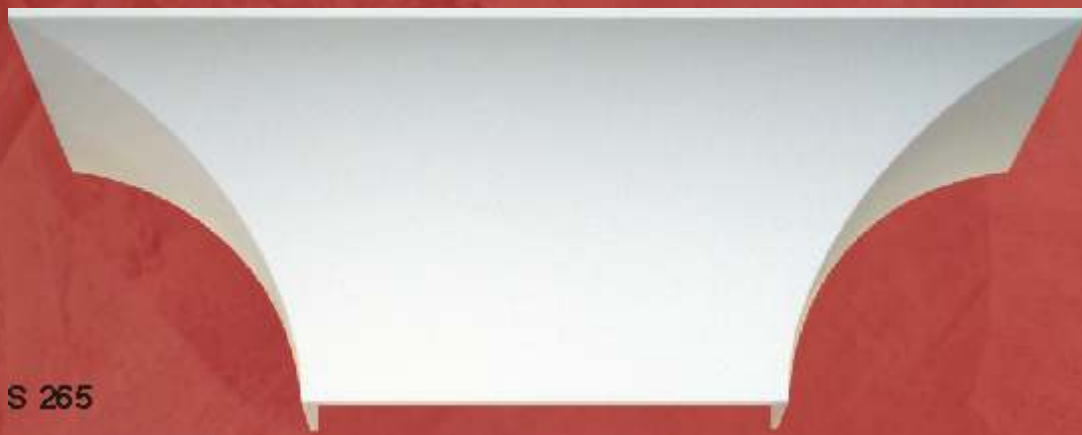

S 265

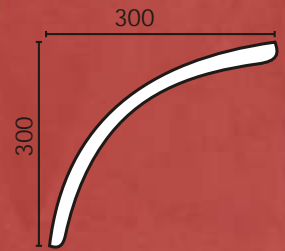
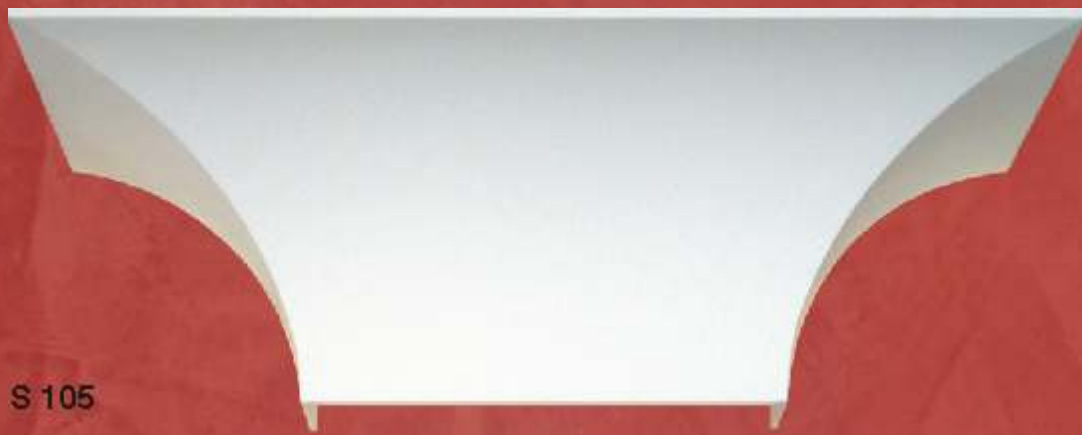

S 105

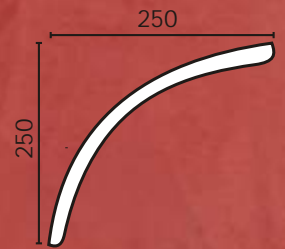
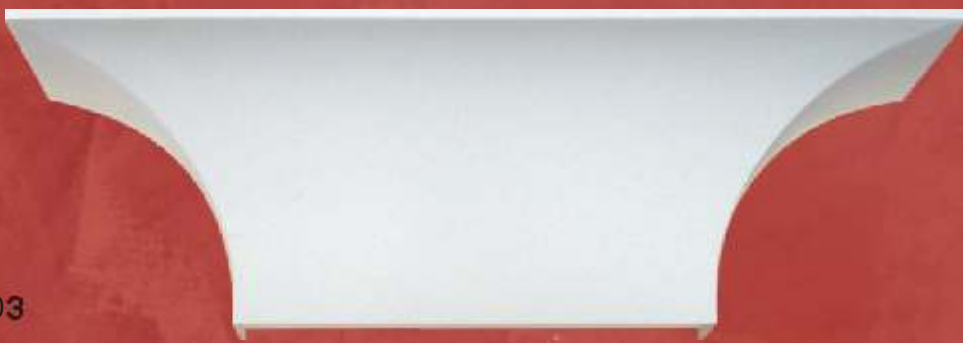

S 103

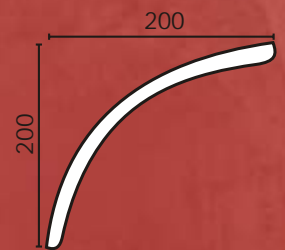

S 97

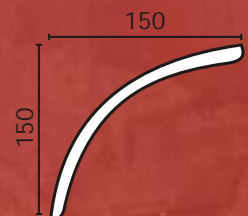
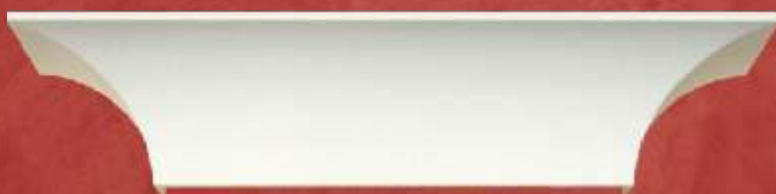

S 84

Cornici



S 104

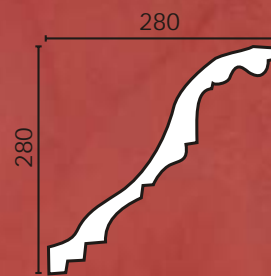

S 153

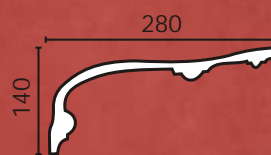

S 98

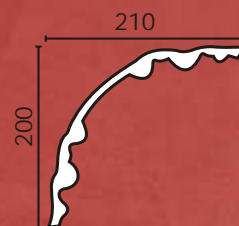

S 244

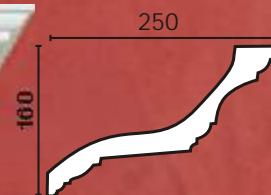

S 189

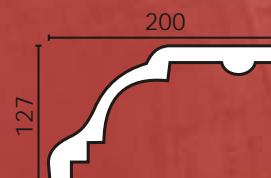

S 44



Cornici



S 271

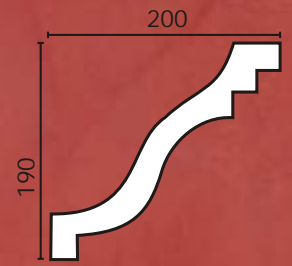

S 100

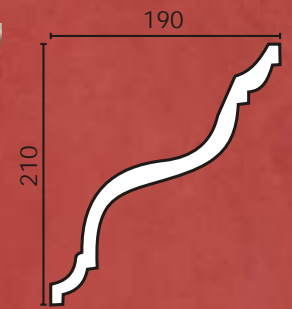

S 91

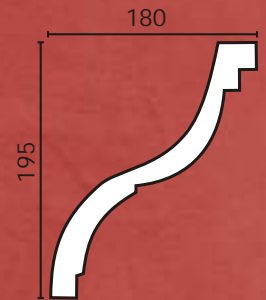

S 250

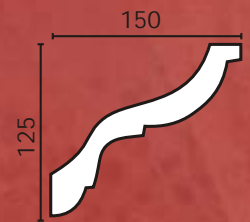

S 76

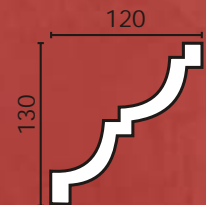

S 63

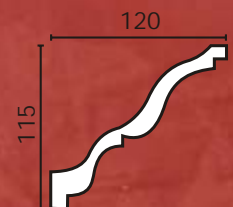

Cornici

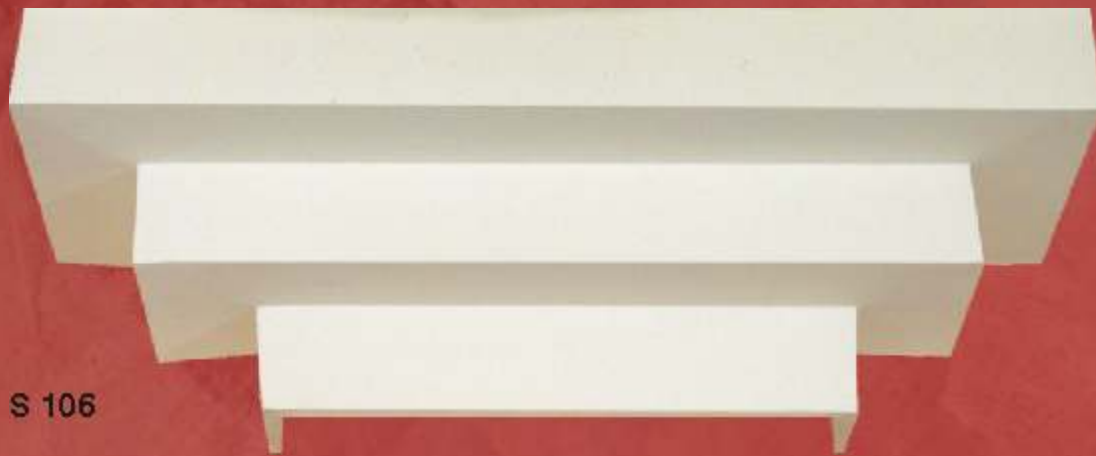

S 106

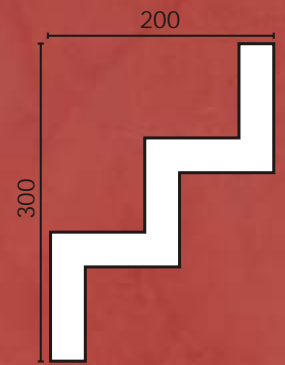

S 99

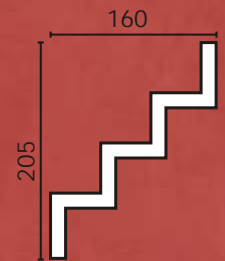

S 75

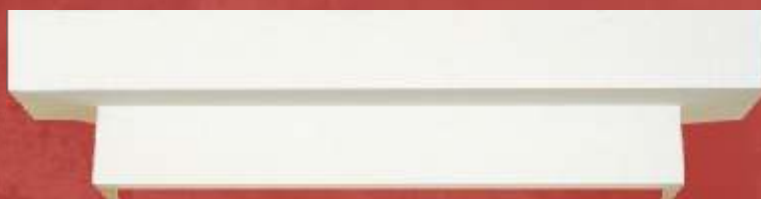
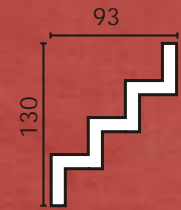

S 83

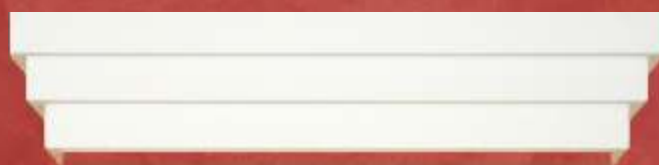

S 60

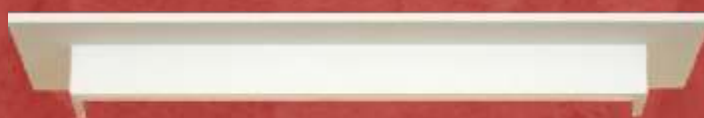

S 12

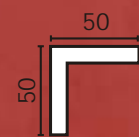

S 179



Cornici



S 116



S 114



S 112

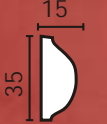

S 223



S 259

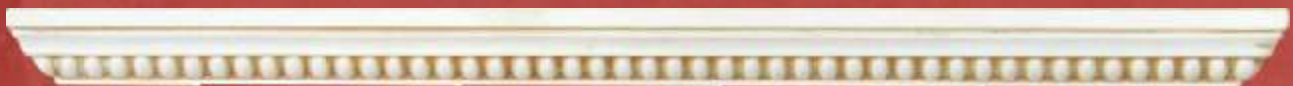

S 292



S 293



S 258



S 111



S 108



S 109



S 113

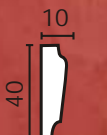

S 294



S 115



Cornici



Cornici

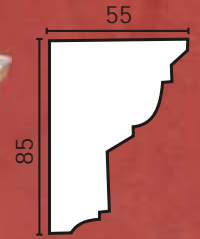

S 128



S 246



S 152



S 228



S 222



S 227



S 237



S 139

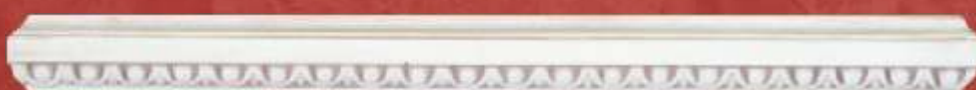

S 239

Cornici

S 272



S 231

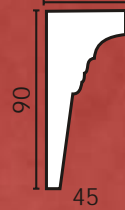

S 217



S 132



S 125



S 119



S 121



S 220



S 291



Cornici



S 289

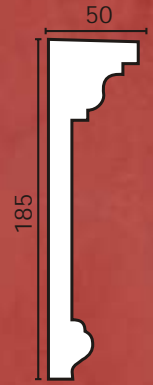

S 276

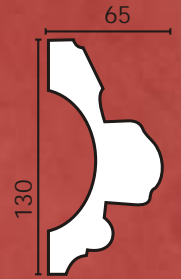

S 256



S 278



S 133



S 224



S 147



S 137

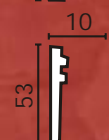

Cornici

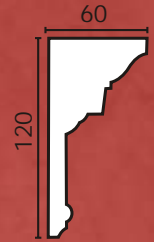
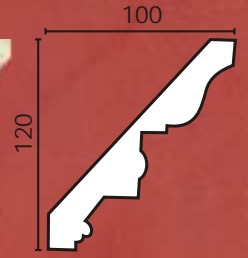

Cornici



S 303

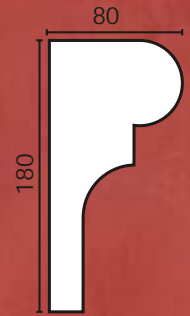

S 304

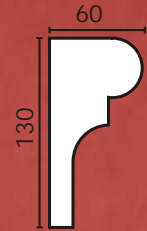

S 305



S 306

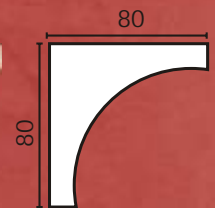

S 308



S 309



S 310



Cornici

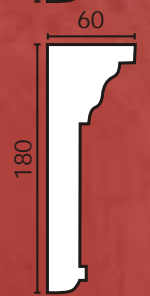
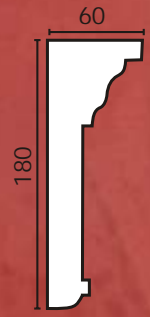
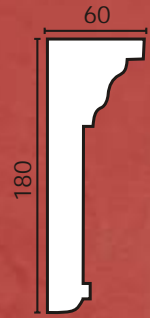
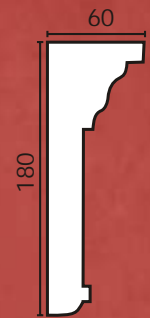
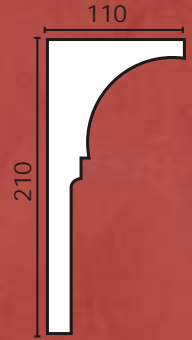

Cornici



S 262 - Abbinamento S 141



S 142 - Abbinamento S 141



S 141 - Abbinamento S 262 - S 142



S 213 - Abbinamento S 236



S 236 - Abbinamento S 213



S 190 - Abbinamento A 40 - A 42

A 42 - (Spigolo)

Cornici



S 230 - Abbinamento S 212



S 212 - Abbinamento S 230

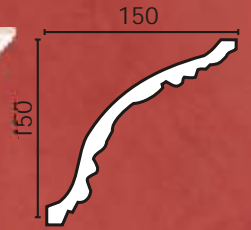

S 205 - Abbinamento S 198



S 198 - Abbinamento S 205

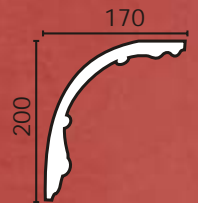

S 268 - Abbinamento S 269



S 269 - Abbinamento S 268



S 194 - Abbinamento A 41



Cornici



S 214 - Abbinamento S 188



S 188 - Abbinamento S 214



S 253 - Abbinamento S 242

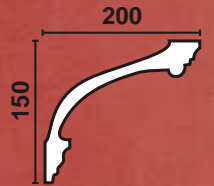

S 242 - Abbinamento S 253



S 260 - Abbinamento S 261

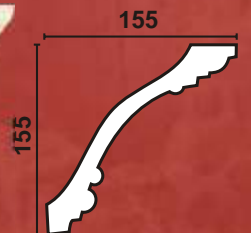

S 261 - Abbinamento S 260

Angoli



A 63
Abbinamento
S 141 - S 142
l. 67 x 67 cm.



A 54
Abbinamento
S 213 - S 236
l. 67 x 67 cm.



A 55
Abbinamento
S 253 - S 242
l. 67 x 67 cm.



A 61
Abbinamento
S 260 - S 261
l. 52 x 52 cm.



A 41
Abbinamento
S 194
l. 28 x 28 cm.



A 40
Abbinamento
S 190
l. 25 x 25 cm.

Cornici



S 208

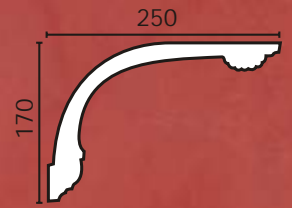

S 243

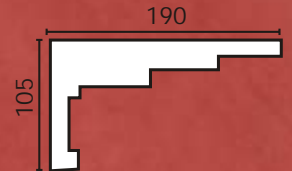

S 215



S 254

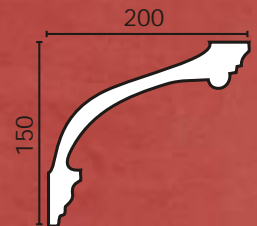

S 151

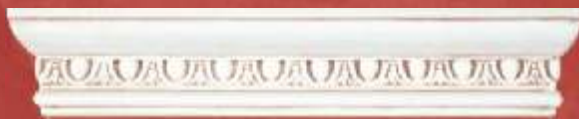
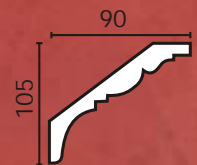

S 226



S 229



S 135



Cornici

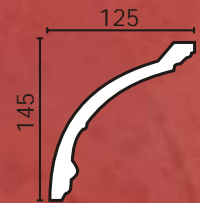
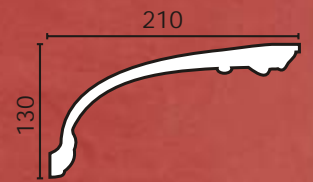
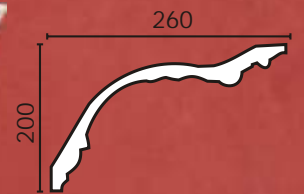
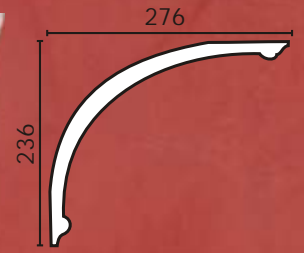

Cornici

S 136

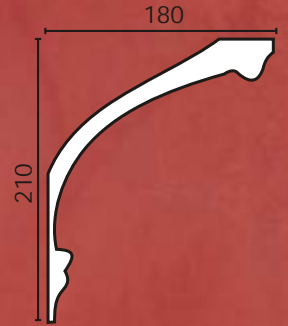

S 266

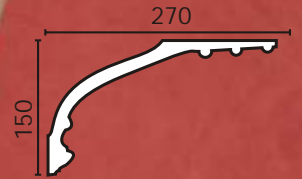

S 255

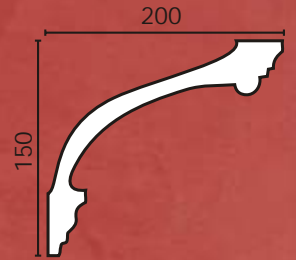

S 218

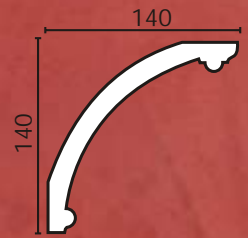

S 221

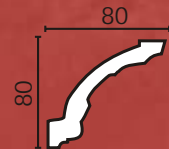

S 203



Cornici



S 204



S 209

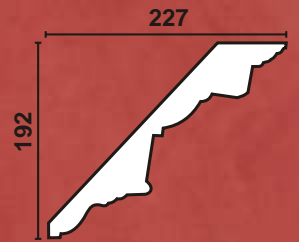

S 146

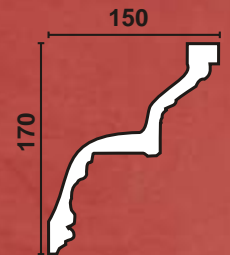

S 290

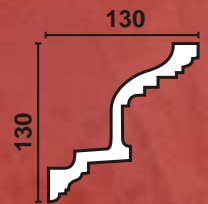

S 134

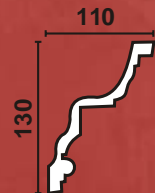

S 143

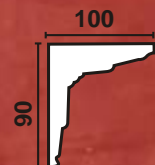



Rosoni



R 113
cm. 240x300
composizione
n. 21 pezzi

Rosoni



R 135
cm. 290x220
composizione
n. 6 pezzi
(escluso rosone)

Rosoni



R 118
cm. 200x120
composizione
n. 4 pezzi
(escluso rosone)



R 117
Ø - cm. 100
composizione
n. 4 pezzi
(escluso rosone)

Rosoni



R 134
Ø cm. 125
composizione
di n. 21 pezzi



R 133
Ø cm. 120
composizione
di n. 24 pezzi

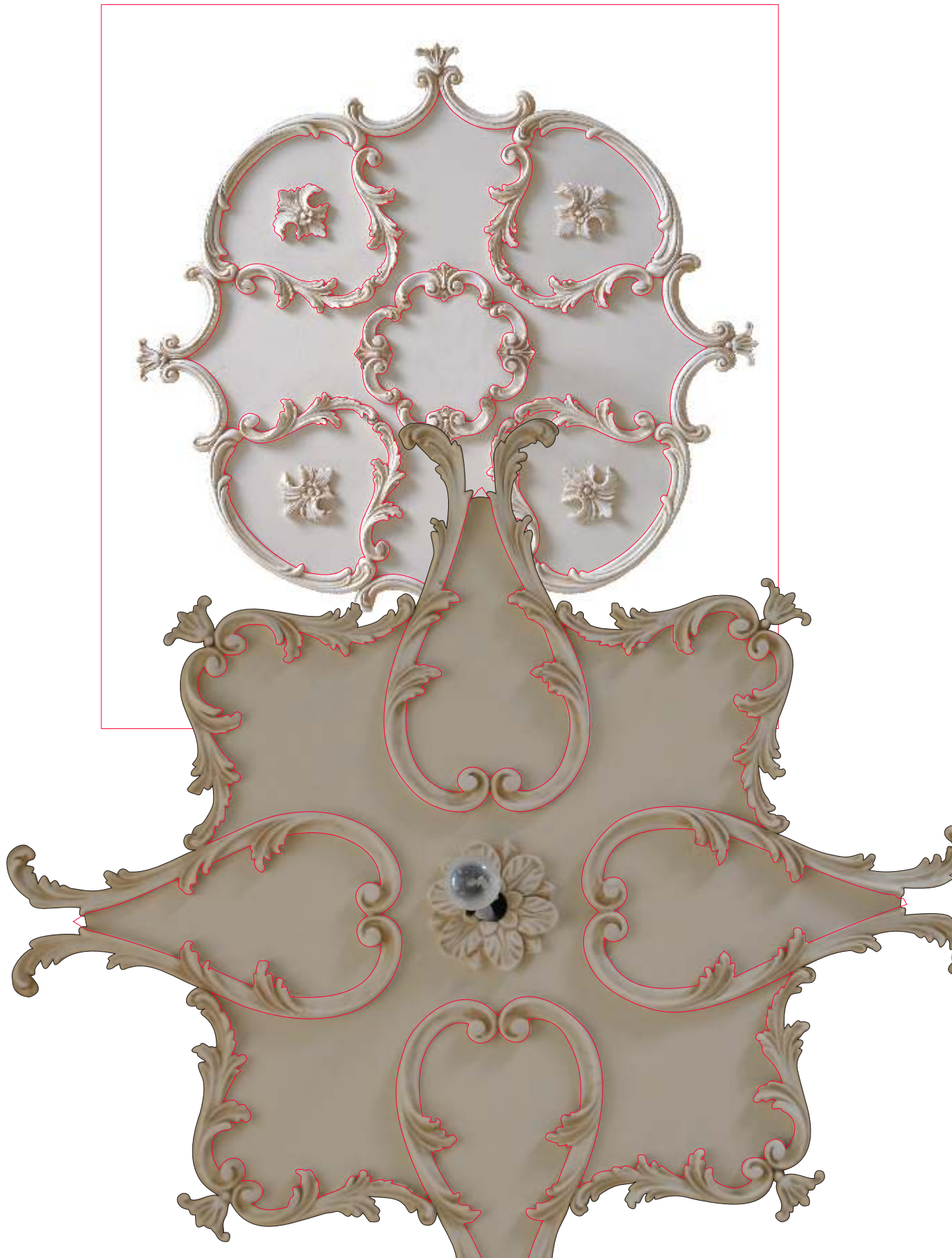

Rosoni



R 108 - cm. 79x88



R 99 - Ø cm. 88

Rosoni



R 97 - Ø cm. 75



R 98 - Ø cm. 75

Rosoni



R 91 - Ø cm. 75



R 103 - cm. 124x78

Rosoni



R 95 - cm. 100x83



R 94 - cm. 94x70

Rosoni



R 46 - Ø cm. 67



R 107 - cm 107x73

Rosoni



R 114 - Ø cm. 70



R 128 - Ø cm. 42



R 126 - Ø cm. 41



R 127 - Ø cm. 41



R 115 - Ø cm. 71



R 125 - Ø cm. 44

Rosoni



R 111 - Ø cm. 23
R 112 - Ø cm. 38



R 100 - Ø cm. 66



R 5 - cm. 81x55



R 12 - Ø cm. 38



R 96 - Ø cm. 66

Rosoni



R 119 - Ø cm. 80



R 136 - Ø cm. 40



R 116 - Ø cm. 48



R 123 - Ø cm. 69



R 124 - Ø cm. 33

Rosoni



R 92 - cm. 97X62



R 78 - Ø cm. 56



R 101 - Ø cm. 58



R 58 - cm 77X67

Rosoni



R 87 - cm. 50X37



R 85 - Ø cm. 51



R 88 - cm. 74X54



R 47 - cm. 58X46



R 89 - Ø cm. 50

Rosoni



R 3 - cm. 59x40



R 76 - Ø cm. 42



R 74 - Ø cm. 50



R 109 - cm. 57x42



R 73 - Ø cm. 55



R 102 - Ø cm. 49

Rosoni



R 80 - Ø cm. 53



R 27 - cm. 70x40



R 77 - cm. 64x40



R 79 - cm. 56x43



R 75 - Ø cm. 52



R 4 - Ø cm. 51

Rosoni



R 83 - Ø cm. 50



R 84 - Ø cm. 52



R 2 - cm. 63x44



R 82 - Ø cm. 58



R 81 - Ø cm. 50



R 11 - cm. 59x39

Rosoni



R 32 - Ø cm. 41



R 37 - Ø cm. 48



R 34 - Ø cm. 32



R 41 - Ø cm. 47



R 9 - Ø cm. 43



R 22 - Ø cm. 39



R 65 - Ø cm. 45



R 44 - Ø cm. 41

Rosoni



R 13 - Ø cm. 63



R 39 - Ø cm. 41



R 106 - Ø cm. 47



R 10 - cm. 52X28



R 19 - Ø cm. 35



R 104 - Ø cm. 45

Rosoni



R 61 - cm. 40x30



R 62 - cm 66x40



R 24 - Ø cm. 35



R 63 - cm. 45x23



R 21 - Ø cm. 24



R 15 - Ø cm. 35



R 59 - Ø cm. 16



R 26 - Ø cm. 30



R 58/1 - Ø cm. 29

Rosoni



R 17 - Ø cm. 47



R 20 - Ø cm. 47



R 29 - Ø cm. 37



R 31 - Ø cm. 44



R 16 - Ø cm. 19



R 48 - Ø cm. 40



R 33 - Ø cm. 41



R 110 - cm. 50X75

Rosoni



R 51 - Ø cm. 45



R 23 - Ø cm. 40



R 18 - Ø cm. 30



R 52 - Ø cm. 38



R 54 - Ø cm. 47



R 53 - cm. 45x31



R 50 - Ø cm. 40



R 49 - cm. 49x38

Rosoni



R 93 - cm. 75X61



R 86 - Ø cm. 50



R 105 - Ø cm. 28



R 45 - cm. 90X65



R 137 - Ø cm. 64
composizione 4 pezzi



R 40 - Ø cm. 70

Rosoni



R 68 - cm. 45x34



R 66 - cm. 40x33



R 67 - Ø cm. 42



R 1 - cm. 41x30



R 69 - cm. 44x31



R 72 - Ø cm. 47



R 70 - Ø cm. 37



R 71 - Ø cm. 35

Rosoni



R 7 - cm. 51x29



R 28 - Ø cm. 41



R 57 - Ø cm. 48



R 55 - cm. 40x25



R 6 - cm. 51x27



R 25 - Ø cm. 16



R 56 - Ø cm. 32



R 14 - Ø cm. 48











Plafoniere



PL 2 - cm. 67x67



PL 73 - cm. 68x72



PL 3 - cm. 52x72



PL 66 - cm. 48x42



PL 78 - cm. 60x60



PL 24 - cm. 73x73



PL 25 - cm. 56x41



PL 71 - Ø cm. 31

Plafoniere



PL 28 - Ø cm. 30



PL 27 - cm. 52x30



PL 30 - cm. 52x52



PL 77 - cm. 63x63



PL 63 - cm. 50x50



PL 75 - cm. 85x85



PL 74 - cm. 60x90



PL 64 - cm. 70x60

Plafoniere



PL 86 - cm. 76x76



PL 87 - cm. 70x75



PL 88 - cm. 63x36



PL 85 - Ø cm. 46



PL 117 - cm. 80x80



PL 118 - cm. 90x90



PL 119 - cm. 70x43



PL 120 - cm. 43x43

Plafoniere



PL 11 - cm. 33x33



PL 12 - cm. 85x45



PL 13 - cm. 70x70



PL 80 - cm. 71x71



PL 22 - cm. 62x62



PL 16 - cm. 53x53



PL 14 - cm. 32x32



PL 15 - cm. 80x31

Plafoniere

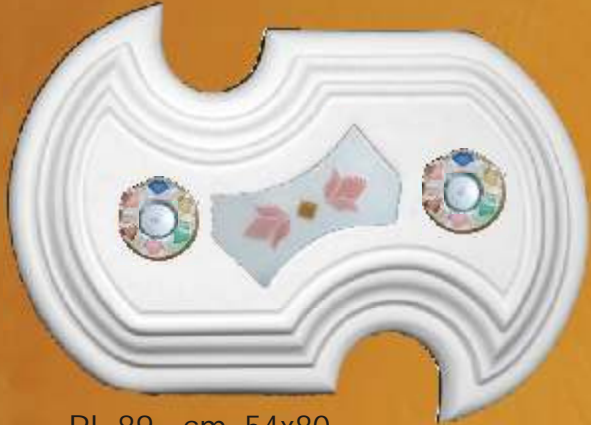

PL 89 - cm. 54x80



PL 68 - cm. 80x80

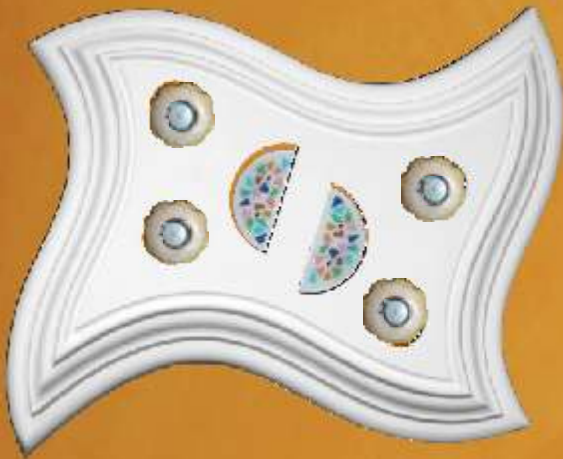

PL 90 - cm. 70x80



PL 91 - cm. 57x57



PL 92 - cm. 95x95

Plafoniere



PL 100 - Ø cm. 90



PL 99 - cm. 90X90



PL 82 - cm. 66x66



PL 83 - cm. 61x63



PL 84 - cm. 66x42



PL 81 - cm. 39x39

Plafoniere



PL 29 - cm. 62x46



PL 48 - cm. 80x70



PL 95 - cm. 70x49



PL 18 - cm. 30x30



PL 34 - cm. 37x37



PL 96 - cm. 28x32

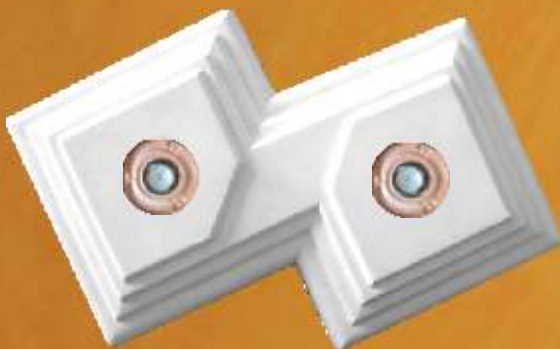

PL 113 - cm. 74x57



PL 69 - cm. 78x78

Plafoniere



PL 50 - Ø cm. 43
PL 7 - Ø cm. 53
PL 51 - Ø cm. 65



PL 60 - Ø cm. 41
PL 61 - Ø cm. 50
PL 62 - Ø cm. 63



PL 93 - Ø cm. 64

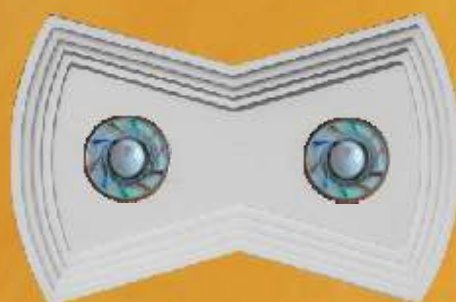

PL 94 - cm. 58x37

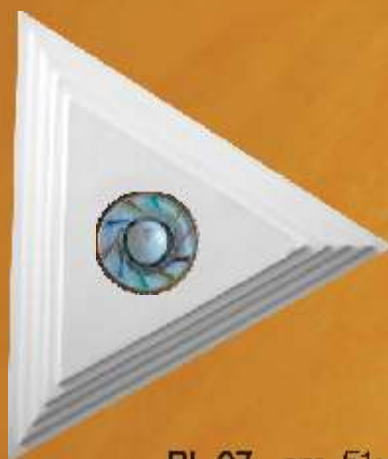

PL 97 - cm. 51x51

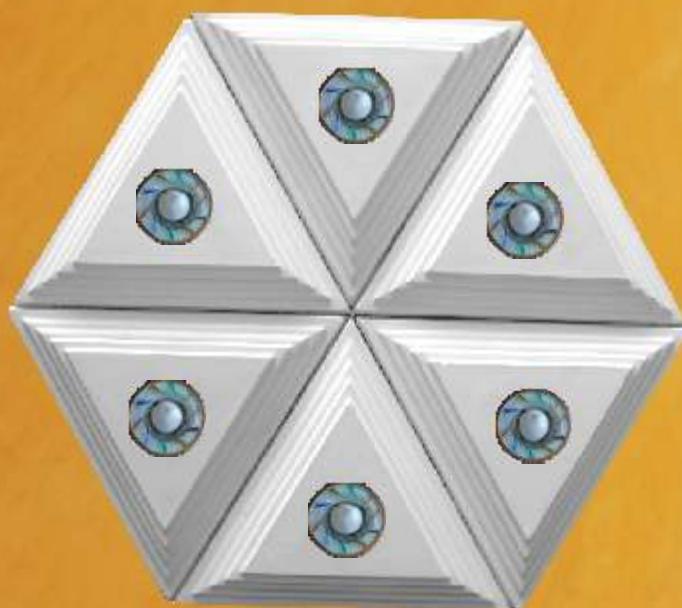

PL 98 - Ø cm. 90

Plafoniere



PL 101 - cm. 47x50



PL 102 - Ø cm. 35



PL 103 - cm. 48x33

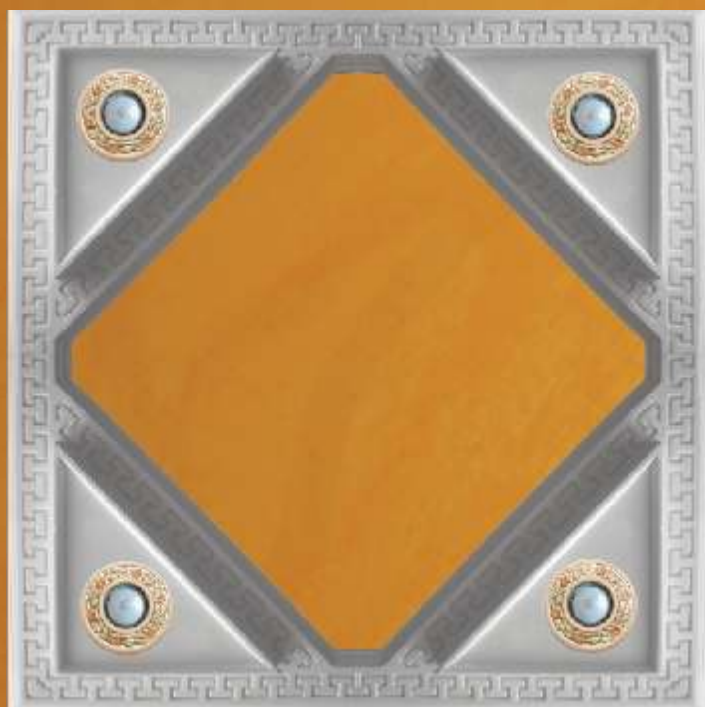

PL 121 - cm. 100x100



PL 107 - cm. 50x50



PL 108 - cm. 33x33

S 224

Appliques



AP 5 - larg. cm. 43
- alt. cm. 24
- prof. cm. 7



AP 3 - larg. cm. 23
- alt. cm. 30
- prof. cm. 14



AP 11 - larg. cm. 39
- alt. cm. 22
- prof. cm. 8



AP 1 - larg. cm. 40
- alt. cm. 20
- prof. cm. 9



AP 13 - larg. cm. 34
- alt. cm. 25
- prof. cm. 8



AP 16 - larg. cm. 41
- alt. cm. 20
- prof. cm. 6

Plafoniere

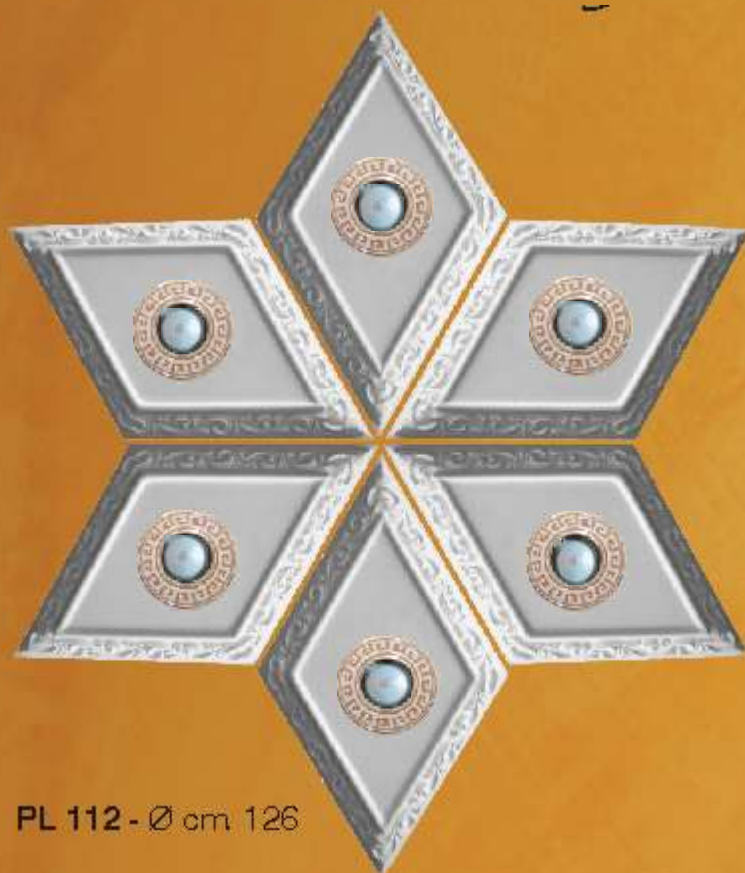

PL 112 - Ø cm 126



PL 111 - Ø cm 72



PL 110 - cm. 63x36



PL 104 - Ø cm 76



PL 105 - cm. 38x65

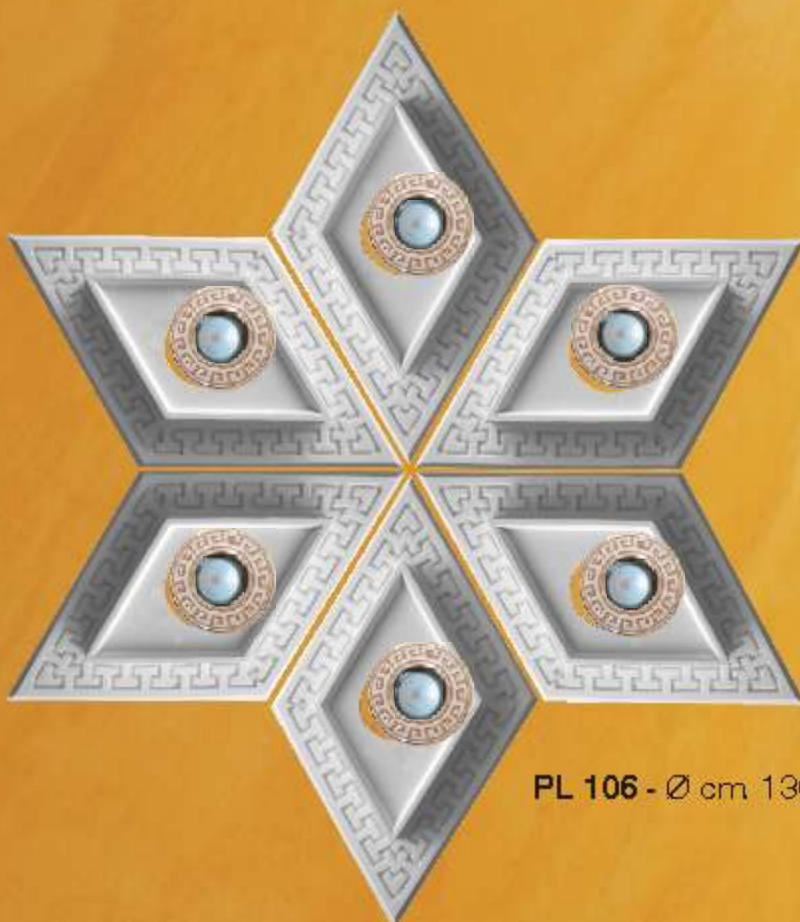

PL 106 - Ø cm 130

Plafoniere

PL 113/1
cm. 31x16



PL 114 - cm. 31x180



PL 115
cm. 32x16



PL 116 - cm. 32x178



Appliques



AP 31 - larg. cm. 31
- alt. cm. 24
- prof. cm. 15



AP 32 - larg. cm. 27
- alt. cm. 10
- prof. cm. 14



AP 35 - larg. cm. 31
- alt. cm. 13
- prof. cm. 15



AP 36 - larg. cm. 32
- alt. cm. 16
- prof. cm. 16



AP 38 - larg. cm. 35
- alt. cm. 12
- prof. cm. 14



AP 39 - larg. cm. 42
- alt. cm. 21
- prof. cm. 21



AP 40 - larg. cm. 35
- alt. cm. 19
- prof. cm. 15



AP 41 - larg. cm. 30
- alt. cm. 15
- prof. cm. 15

Appliques



AP 12 - larg. cm. 30
- alt. cm. 31
- prof. cm. 17



AP 9 - larg. cm. 29
- alt. cm. 29
- prof. cm. 13



AP 14 - larg. cm. 30
- alt. cm. 14
- prof. cm. 14



AP 15 - larg. cm. 42
- alt. cm. 14
- prof. cm. 16



AP 33 - larg. cm. 30
- alt. cm. 16
- prof. cm. 15



AP 17 - larg. cm. 35
- alt. cm. 18
- prof. cm. 18

Appliques



AP 22 - larg. cm. 32
- alt. cm. 21
- prof. cm. 14



AP 19 - larg. cm. 30
- alt. cm. 18
- prof. cm. 18



AP 20 - larg. cm. 38
- alt. cm. 22
- prof. cm. 19



AP 21 - larg. cm. 25
- alt. cm. 20
- prof. cm. 13



AP 18 - larg. cm. 32,5
- alt. cm. 17
- prof. cm. 17



AP 24 - larg. cm. 29
- alt. cm. 25
- prof. cm. 14

Nicchie e Griglie



PA 9 - l. cm. 70
p. cm. 20
h. cm. 114



PA 5 - l. cm. 43
p. cm. 17
h. cm. 74

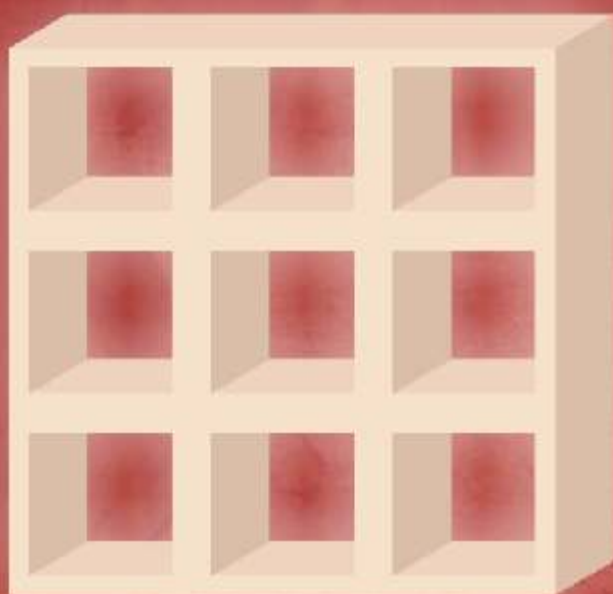

PA 4 - l. cm. 50x50
p. cm. 8



CO 41 - l. cm. 40
h. cm. 80

Appliques



AP 25 - larg. cm. 31
- alt. cm. 12
- prof. cm. 16



AP 26 - larg. cm. 29
- alt. cm. 12
- prof. cm. 28



AP 27 - larg. cm. 33
- alt. cm. 13
- prof. cm. 13



AP 28 - larg. cm. 35
- alt. cm. 13
- prof. cm. 13



AP 29 - larg. cm. 27
- alt. cm. 18
- prof. cm. 13



AP 30 - larg. cm. 30
- alt. cm. 15
- prof. cm. 15



AP 2 - larg. cm. 25
- alt. cm. 17
- prof. cm. 17



AP 8 - larg. cm. 34
- alt. cm. 17
- prof. cm. 10

Pannelli per boiserie



PA 6 - (cornice sup. e inf.)
l. 150 x h. 19,5 cm.

PA 7 - (raccordo)
l. 68 x h.86 cm.

PA 10 - (cornicetta superiore)
l. 150 x h. 5 cm.



PA 8 - (pannello)
l. cm. 100 - h. cm. 80

S 11 - (cornicetta superiore) cm. 180 x 5



PA 3 - (raccordo)
l.55 x h100 cm.

PA 2 - (cornice inferiore)
l. 160 x h. 17 cm.

PA 1 - (cornice superiore)
l. 160 x h. 13 cm.

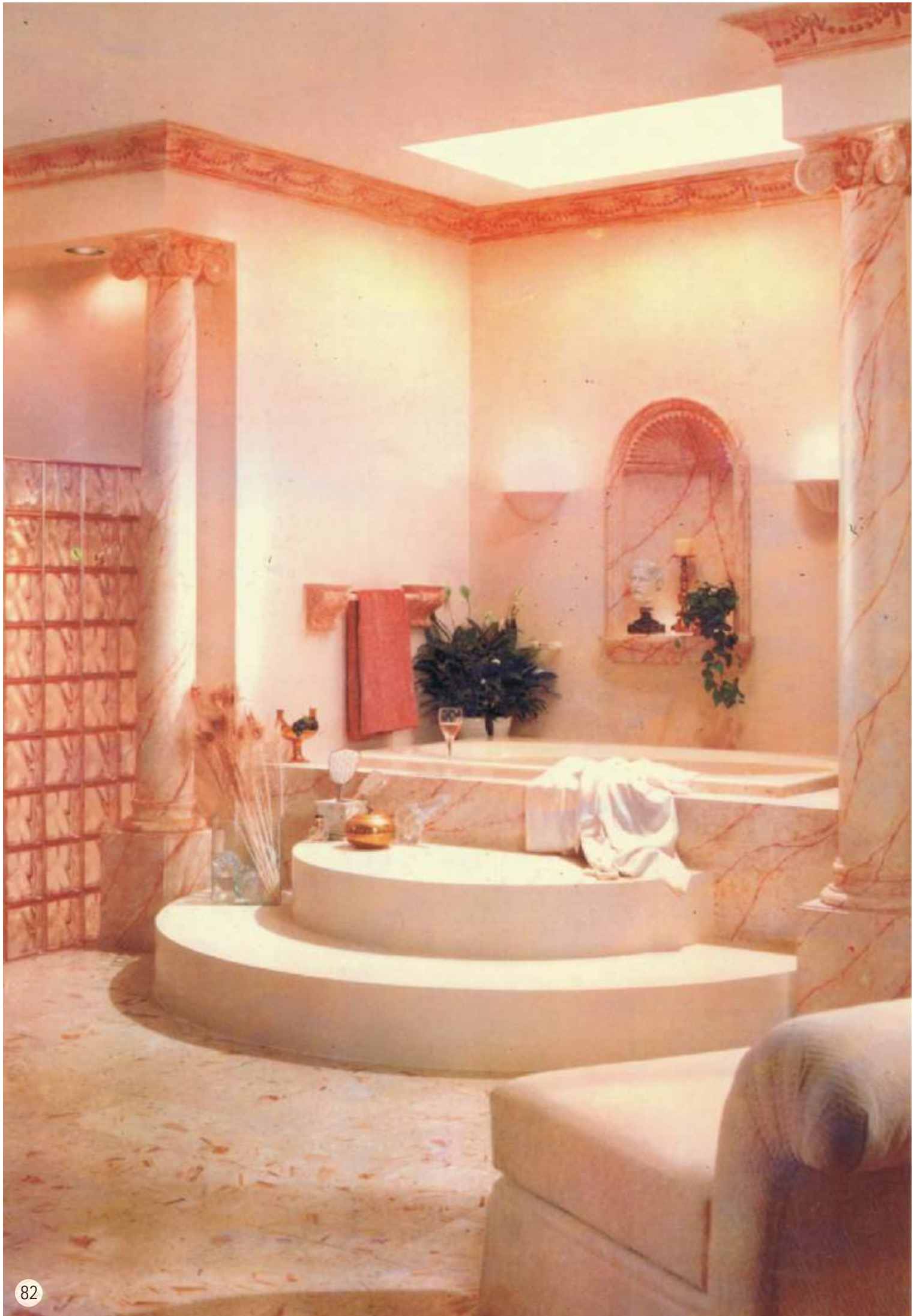

Sopraporte



SOP 12 - cm. 147x46



SOP 7 - cm. 142x39



SOP 6 - cm. 130x24



SOP 18 - cm. 164x28

Sopraporte



SOP 1 - cm. 127X30



SOP 2 - cm. 128X39



SOP 3 - cm. 130X25



SOP 4 - cm. 100x30



SOP 5 - cm. 100x30

Sopraporte



SOP 16 - cm. 100x33



SOP 13 - cm. 98x24,5



SOP 15 - cm. 100x30



SOP 11 - cm. 100x27



SOP 10 - cm. 110x40

Sopraporte



SOP 14 - cm. 120x44



SOP 8 - cm. 110x25



SOP 9 - cm. 111x27



SOP 17 - cm. 117,5x22,5



SOP 19 - cm. 119x20

Colonne

CA 44 - Ø sup. cm. 55
Ø inf. cm. 28
h. cm. 15

CA 33 - Ø sup. cm. 42,5
Ø inf. cm. 33
h. cm. 26

CA 40 - l. cm. 20
Ø inf. cm. 15
h. cm. 15

CA 42 - l. cm. 25
l. cm. 16
h. cm. 20

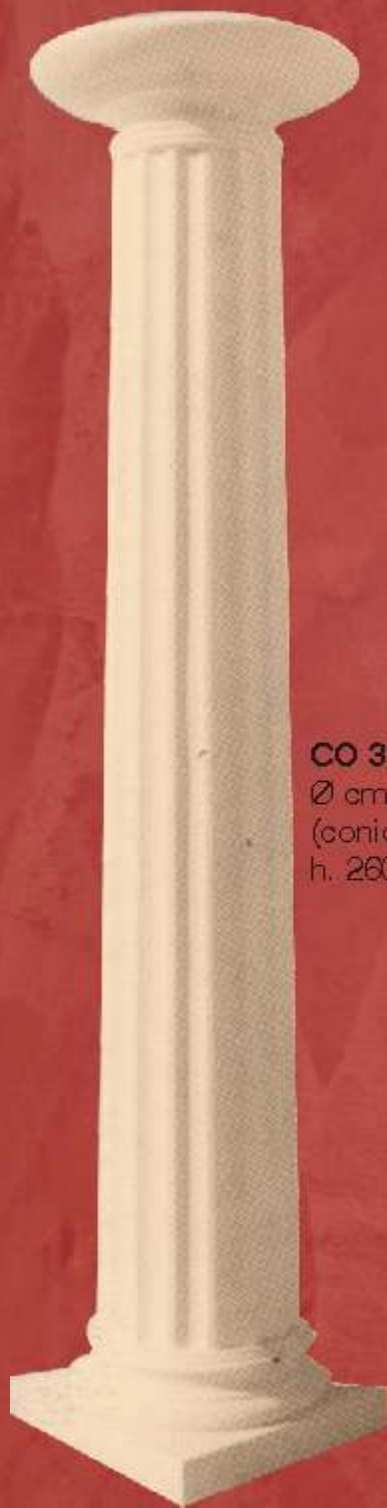

CO 33
Ø cm. 32x25
(conica)
h. 260



CO 28
Ø cm. 29
h. cm. 250



CO 31
Ø cm. 20x15
(conica)
h. cm. 280



CO 32
cm. 16
(quadrata)
h. cm. 254

B 29 - Ø cm. 34
l. cm. 47
h. cm. 20

B 32 - Ø cm. 32
l. cm. 40
h. cm. 20

B 6 - Ø cm. 22
l. cm. 32
h. cm. 19

B 27 - l. cm. 16
l. cm. 23
h. cm. 12

Colonne

CA 106 - Ø sup. cm. 43
Ø inf. cm. 32
h. cm. 15

CA 105 - Ø sup. cm. 38
Ø inf. cm. 26
h. cm. 15

CA 104 - Ø sup. cm. 36
Ø inf. cm. 24
h. cm. 15



CO 27
Ø cm. 30
h. cm. 255



CO 38
Ø cm. 25
h. cm. 280



CO 25
Ø cm. 22
h. cm. 280

B 42 - Ø cm. 31
l. cm. 46
h. cm. 23

B 41 - Ø sup. cm. 26
l. cm. 40
h. cm. 23

B 40 - Ø sup. cm. 24
l. cm. 38
h. cm. 23

Colonne

CA 103 - Ø sup. cm. 30
Ø inf. cm. 22
h. cm. 12,5

CA 102 - Ø sup. cm. 22
Ø inf. cm. 16,5
h. cm. 9

CA 101 - Ø sup. cm. 20
Ø inf. cm. 14,5
h. cm. 8

CA 100 - Ø sup. cm. 12
Ø inf. cm. 8,5
h. cm. 5



CO 6
Ø cm. 20
h. cm. 265



CO 24
Ø cm. 15
h. cm. 280



CO 23
Ø cm. 13,5
h. cm. 250



CO 22
Ø cm. 8
h. cm. 250

B 6 - Ø sup. cm. 22
l. cm. 32
h. cm. 19

B 37 - Ø sup. cm. 16,5
l. cm. 24
h. cm. 14

B 36 - Ø sup. cm. 14,5
l. cm. 22
h. cm. 13

B 33 - Ø sup. cm. 8,5
l. cm. 14
h. cm. 8,5

Colonne

CA 36 - l. cm. 52
h. cm. 27
Ø cm. 32

CA 80 - l. cm. 42
h. cm. 16
Ø cm. 26

CA 35 - l. cm. 36
h. cm. 28
Ø cm. 24



CO 29
Ø cm. 30
h. cm. 250



CO 40
Ø cm. 25
h. cm. 250



CO 20
Ø cm. 22
h.cm.260

B 42 - l. cm. 46
h. cm. 23
Ø cm. 32

B 41- l. cm. 40
h. cm. 23
Ø cm. 26

B 40 - l. cm. 38
h. cm. 23
Ø cm. 24

Colonne

CA 4 - l. cm. 36
h. cm. 32
Ø cm. 22

CA 73 - l. cm. 28
h. cm. 23
Ø cm. 16

CA 72 - l. cm. 25
h. cm. 21
Ø cm. 14

CA 69 - l. cm. 15
h. cm. 12
Ø cm. 9



CO 5
Ø cm. 20
h. cm. 250



CO 21
Ø cm. 15
h. cm. 220



CO 7
Ø cm. 13,5
h. cm. 255



CO 4
Ø cm. 8
h. cm. 255

B 6 - l. cm. 32
h. cm. 19
Ø cm. 22

B 37 - l. cm. 24
h. cm. 14
Ø cm. 16

B 36 - l. cm. 21
h. cm. 14
Ø cm. 14

B 33 - l. cm. 14
h. cm. 8,5
Ø cm. 9

Lesene

CA 78 - l.sup. cm. 38
l. inf. cm. 30
h. cm. 11,5



CA 77 - l.sup. cm. 33
l. inf. cm. 26
h. cm. 11,5



CA 76 - l.sup. cm. 29
l. inf. cm. 20
h. cm. 11,5



CO 26
l. cm. 30
h. cm. 260

CO 9
l. cm. 26
h. cm. 260

CO 30
l. cm. 20
h. cm. 250

B 45 - l.sup. cm. 30
l. inf. cm. 39,5
h. cm. 14

B 46 - l.sup. cm. 26
l. inf. cm. 34,5
h. cm. 14

B 47 - l.sup. cm. 20
l. inf. cm. 29
h. cm. 14

Lesene

CA 91 - l.sup. cm. 24
l. inf. cm. 16
h. cm. 11,5



CA 82 - l.sup. cm. 20
l. inf. cm. 12
h. cm. 11,5



CA 81 - l.sup. cm. 18
l. inf. cm. 10
h. cm. 11,5



CA 93 - l.sup. cm. 16
l. inf. cm. 8
h. cm. 11,5



CO 11
l. cm. 16
h. cm. 276

CO 36
l.cm.12
h. cm. 242

CO 35
l.cm.10
h. cm. 200

CO 34
l.cm.8
h.cm.230

B 48 - l. sup. cm. 16
l. inf. cm. 22,5
h. cm. 11

B 49 - l. sup. cm. 12
l. inf. cm. 19
h. cm. 11

B 50 - l. sup. cm. 10
l. inf. cm. 17
h. cm. 11

B 51- l.sup. cm. 8
l. inf. cm. 15
h. cm. 11

Archi



Arco tutto sesto



Arco sesto rilevato



Arco Impero



Arco scemo

Capitelli



CA 79 - h. cm. 57
l. cm. 40 x 68



CA 10 - h. cm. 20
l. cm. 27 x 40



CA 16 - h. cm. 36
l. cm. 50x31



CA 69 - h. cm. 12
l. cm. 15 x Ø cm. 8
CA 70 - h. cm. 15
l. cm. 18 x Ø cm. 10
CA 71 - h. cm. 18
l. cm. 21 x Ø cm. 12
CA 72 - h. cm. 21
l. cm. 25 x Ø cm. 14

CA 73 - h. cm. 23
l. cm. 28 x Ø cm. 16
CA 4 - h. cm. 32
l. cm. 36 x Ø cm. 20
CA 74 - h. cm. 26
l. cm. 30 x Ø cm. 18
CA 94 - h. cm. 28
l. cm. 36 x Ø cm. 22

Capitelli



CA 75 - h. cm. 53
l. cm. 60 x Ø cm. 32



CA 59 - h. cm. 16
l. cm. 26 x Ø cm. 14



CA 11 - h. cm. 20
l. cm. 16 x 25



CA 93 - h. cm. 11
l. cm. 8 x 16

CA 81 - h. cm. 11
l. cm. 10 x 18

CA 82 - h. cm. 11
l. cm. 12 x 20

CA 91 - h. cm. 11
l. cm. 16 x 24

CA 76 - h. cm. 11
l. cm. 20 x 29

CA 77 - h. cm. 11
l. cm. 26 x 33

CA 78 - h. cm. 11
l. cm. 30 x 38



CA 62 - h. cm. 17
l. cm. 12 x 18

Capitelli



CA 37 - h. cm. 30
l. cm. 30 x Ø cm. 20



CA 40 - h. cm. 15
l. cm. 20 x Ø cm. 15



CA 92 - h. cm. 16,5
l. cm. 35 x Ø cm. 20



CA 58 - h. cm. 14
l. cm. 30 x Ø cm. 22



CA 7 - h. cm. 15
l. cm. 37 x Ø cm. 26

Capitelli



CA 45 - h. cm. 12
l. cm. 30 x Ø cm. 25



CA 65 - h. cm. 10
l. cm. 11,5 x Ø cm. 8



CA 87 - h. cm. 7,5
l. cm. 8 x 10



CA 86 - h. cm. 11,5
l. cm. 8 x 11



CA 66 - h. cm. 7,5
l. cm. 12 x Ø cm. 8



CA 88 - h. cm. 3,5
l. cm. 8 x 11



CA 107 - h. cm. 8,5
l. cm. 15 x Ø cm. 8



CA 38 - h. cm. 11
l. cm. 22 x Ø cm. 15

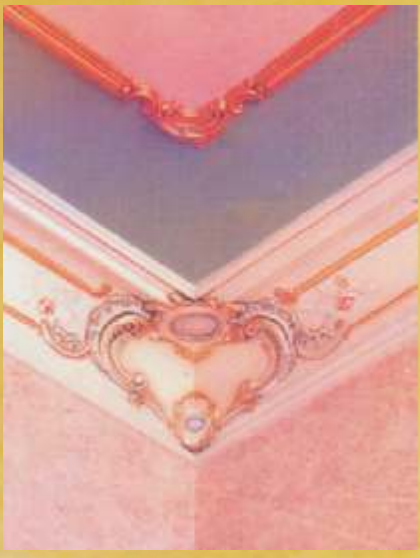

Basi



B 10 - h. cm. 11
l. cm. 40 x 30
B 10/1 - h. cm. 11
l. cm. 36 x 26



B 32 - h. cm. 18
l. cm. 12 x 18



B 28 - h. cm. 31
l. cm. 27 x 36



B 9 - h. cm. 15
l. cm. 25 x Ø 18



B 43 - h. cm. 5
l. cm. 15 x Ø cm. 10



B 51 - h. cm. 11
l. cm. 8 x 15
B 50 - h. cm. 11
l. cm. 10 x 17
B 49 - h. cm. 11
l. cm. 12 x 19
B 48 - h. cm. 11
l. cm. 16 x 22,5
B 47 - h. cm. 11
l. cm. 20 x 29
B 46 - h. cm. 14
l. cm. 20 x 29
B 45 - h. cm. 14
l. cm. 30 x 39,5



B 13 - h. cm. 7,5
l. cm. 23,5 x Ø cm. 16

Basi



- B 33 - h. cm. 8,5
l. cm. 14 x Ø cm. 8
- B 34 - h. cm. 10
l. cm. 16 x Ø cm. 10
- B 35 - h. cm. 11
l. cm. 19 x Ø cm. 12
- B 36 - h. cm. 13
l. cm. 21 x Ø cm. 14
- B 37 - h. cm. 14
l. cm. 24 x Ø cm. 16
- B 38 - h. cm. 17
l. cm. 27 x Ø cm. 18
- B 6 - h. cm. 19
l. cm. 32 x Ø cm. 22
- B 40 - h. cm. 23
l. cm. 38 x Ø cm. 24
- B 41 - h. cm. 23
l. cm. 40 x Ø cm. 26
- B 42 - h. cm. 23
l. cm. 46 x Ø cm. 32



B 9/1 - h. cm. 15
l. cm. 20 x 22



B 44 - h. cm. 5
l. cm. 14 x Ø cm. 8



B 30 - h. cm. 12
l. cm. 10 x 13



B 26 - h. cm. 33
l. cm. 31 x 35

Reggimensole



CA 46 - larg. cm. 16
- alt. cm. 54
- prof. cm. 26



CA 48 - larg. cm. 38
- alt. cm. 50
- prof. cm. 13



CA 47 - larg. cm. 24
- alt. cm. 50
- prof. cm. 17



CA 49 - larg. cm. 32
- alt. cm. 43
- prof. cm. 23



CA 21 - larg. cm. 24
- alt. cm. 38,5
- prof. cm. 16



CA 31 - larg. cm. 28
- alt. cm. 48
- prof. cm. 24

Reggimensole



CA 90 - larg. cm. 30
- alt. cm. 46
- prof. cm. 14



CA 95 - larg. cm. 38
- alt. cm. 38
- prof. cm. 17



CA 99 - larg. cm. 10
- alt. cm. 45
- prof. cm. 8



CA 100 - larg. cm. 17
- alt. cm. 30
- prof. cm. 22



CA 97 - larg. cm. 22
- alt. cm. 40,5
- prof. cm. 8,5

CA 96 - larg. cm. 7,5
- alt. cm. 9,5
- prof. cm. 3,5



CA 98 - larg. cm. 15
- alt. cm. 27,5
- prof. cm. 8,5



Reggimensole



CA 55
- larg. cm. 25
- alt. cm. 30,5
- prof. cm. 17

CA 2
- larg. cm. 20
- alt. cm. 36
- prof. cm. 21



CA 14 - larg. cm. 25
- alt. cm. 30
- prof. cm. 21



CA 56 - larg. cm. 12,5
- alt. cm. 17
- prof. cm. 6,5



CA 1 - larg. cm. 10,5
- alt. cm. 17
- prof. cm. 8,5



CA 22
- larg. cm. 14
- alt. cm. 21
- prof. cm. 7,5



CA 27 - larg. cm. 21
- alt. cm. 26
- prof. cm. 10



CA 57 - larg. cm. 19,5
- alt. cm. 23,5
- prof. cm. 8,5

Reggimensole



CA 17 - larg. cm. 23
- alt. cm. 30
- prof. cm. 10



CA 53 - larg. cm. 16,5
- alt. cm. 33
- prof. cm. 19



CA 51 - larg. cm. 24
- alt. cm. 26
- prof. cm. 24



CA 29 - larg. cm. 15
- alt. cm. 32
- prof. cm. 40



CA 52 - larg. cm. 9
- alt. cm. 15
- prof. cm. 7,5



CA 54 - larg. cm. 16
- alt. cm. 28
- prof. cm. 12



CA 50 - larg. cm. 13,5
- alt. cm. 31
- prof. cm. 6,5



CA 13 - larg. cm. 15
- alt. cm. 15
- prof. cm. 10

Reggimensole



CA 63
- larg. cm. 22
- alt. cm. 26,5
- prof. cm. 12



CA 68
- larg. cm. 21
- alt. cm. 30
- prof. cm. 14



CA 85
- larg. cm. 14,5
- alt. cm. 30,5
- prof. cm. 8



CA 84
- larg. cm. 11
- alt. cm. 31
- prof. cm. 7



CA 64
- larg. cm. 15
- alt. cm. 30
- prof. cm. 7



CA 67 - larg. cm. 9
- alt. cm. 18
- prof. cm. 18



CA 83 - larg. cm. 12
- alt. cm. 18
- prof. cm. 9,5



CA 61 - larg. cm. 15
- alt. cm. 18
- prof. cm. 6



Tozzetti e Chiavi



T 13 - cm. 26x27



T 1 - cm. 13x13



T 2 - cm. 13x13



T 3 - cm. 13x13



T 4 - cm. 10x10



T 5 - cm.



T 6 - cm. 19x19



T 7 - cm. 10x10



T 8 - cm. 14x16



T 9 - cm. 10x10



T 10 - cm. 10x10



T 11 - cm. 14x12



T 12 - cm. 11x11



T 14 - cm. 13x13

Angoli



A 35 - cm. 28x15



A 75 sx - cm. 6x5



A 76 dx - cm. 6x5



A 44 - cm. 23x12



A 88 - cm. 10x7



A 58 - cm. 16x11



A 86 - cm. 8x12



A 85 - cm. 12x11



A 67 - Ø cm. 8



A 69 - Ø cm. 6



A 68 - Ø cm. 10



A 84 - cm. 9x6



A 83 - cm. 13x13



A 46 - cm. 16x20



A 87 - cm. 12x10



R 129 - - Ø cm. 20



A 89 - cm. 8x9



R 59 - Ø cm. 16



R 130 - Ø cm. 17



R 131 - Ø cm. 15



R 132 - Ø cm. 15

Angoli



A 77 - Abbinamento S 277



A 74 - Abbinamento S 293



A 49



A 25 - cm. 47x26



A 53 - cm. 70x36 - Abb. S 239



A 52 - cm. 48x48 - Abb. S 239

Angoli



A 24 - cm. 36x19



A 36 - cm. 26x10



A 37 - cm. 26x10



A 66 - cm. 35x17



A 32 - cm. 53x10



A 38 - cm. 40x6



A 7 - cm. 38x9



A 90 - cm. 40x16

Angoli



A 1 - cm. 71x27



A 3 - cm. 75x18



A 4 - cm. 52x15



A 5 - cm. 54x17



A 50 - cm. 52x17



A 51 - cm. 52x17



A 6 - cm. 46x15



A 48 - cm. 45x9



A 47 - cm. 40x12



A 65 - cm. 46x8



A 78 - cm. 24x8



A 79 - cm. 24x8

Angoli



A 10 - Abbinamento S 113



A 8 - Abbinamento S 4



A 12 - Abbinamento S 5



A 11 - Abbinamento S 114



A 13 - Abbinamento S 1



A 71 - Abbinamento S 168



A 60 - Abbinamento S 166



A 64 - Abbinamento S 116



A 57 - Abbinamento S 6



A 31 - Abbinamento S 108



A 34 - Abbinamento S 163



A 27 - Abbinamento S 2



A 29 - Abbinamento S 164



A 23 - Abbinamento S 115



A 73 - Abbinamento S 293



A 80 - cm. 20x11



A 81 - cm. 19x9



A 82 - cm. 12x5

Angoli e Intermezzi



A 14 - Abbinamento S 116



A 16 - Abbinamento S 114



A 19 - Abbinamento S 5



A 17 - Abbinamento S 113



A 15 - Abbinamento S 115



A 56 - Abbinamento S 5



A 45 - Abbinamento S 6



A 59 - Abbinamento S 166



A 39 - Abbinamento S 4



A 30 - Abbinamento S 164



A 33 - Abbinamento S 163



A 22 - Abbinamento S 1



A 21 - Abbinamento S 108



A 28 - Abbinamento S 109



A 20 - Abbinamento S 112



A 70 - Abbinamento S 2



A 26 - Abbinamento S 137



A 72 - Abbinamento S 168



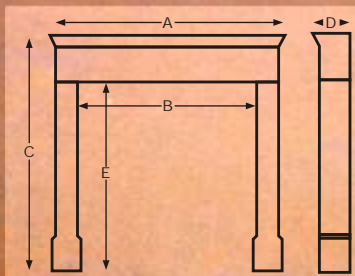

CM 2
A=cm.174
B=cm.92
C=cm.122
D=cm.39
E=cm.85

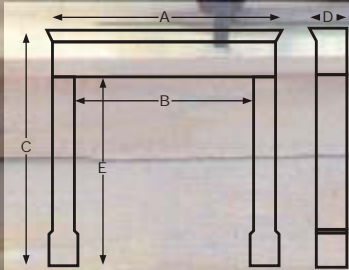

CM 3
A=cm.130
B=cm.85
C=cm.114
D=cm.15
E=cm.86

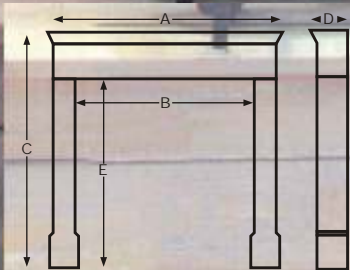

CM 1
A=cm.160
B=cm.92
C=cm.125
D=cm.26
E=cm.91

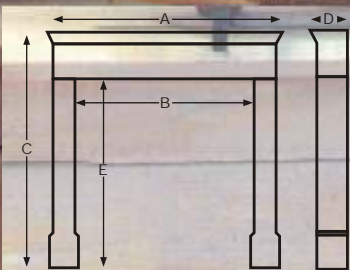

CM 4
A=cm.144
B=cm.81
C=cm.114
D=cm.26
E=cm.87

Camini

CM 5
h. cm. 114
l. cm. 130
p. cm. 25x90x90

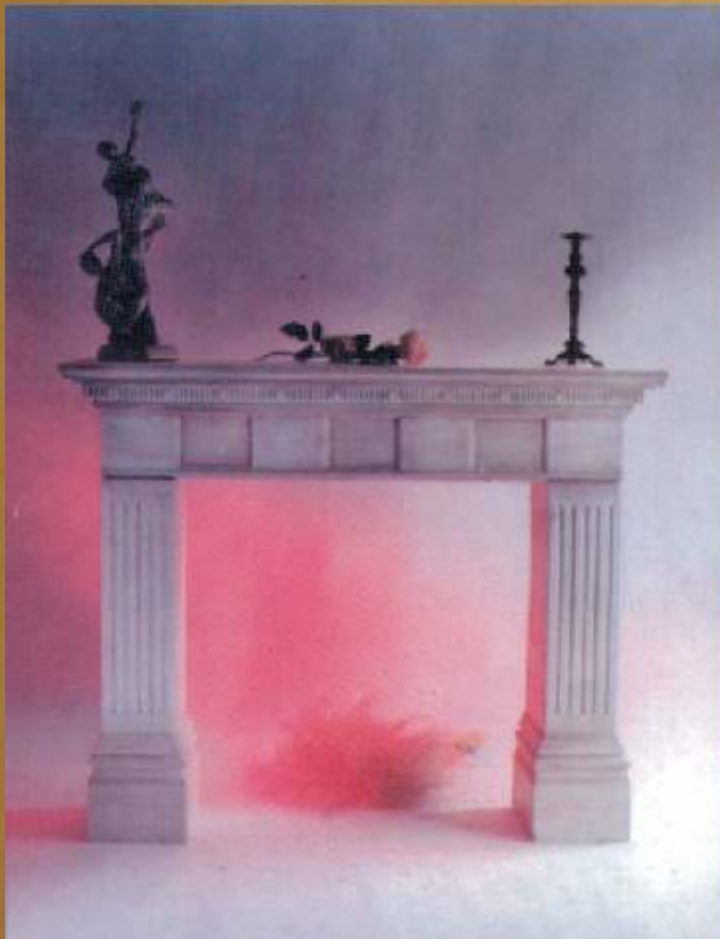

CM 6
h. cm. 112
l. cm. 137
p. cm. 35x87x85



Carissimi clienti,

siamo lieti nel presentarvi il nuovo catalogo degli stucchi aggiornato, rinnovato, con un'ampia gamma di articoli nuovi.

I nostri sono articoli ornamentali, vengono forniti bianchi, senza alcun tipo di trattamento; si tratta naturalmente di articoli in gesso, che possono subire delle variazioni di misure nel corso del tempo per motivi di adattabilità.

Siamo in grado di riprodurre molto manufatti anche se non catalogati, costruiamo archi in cartongesso, curve e archi di qualsiasi tipo, ecc..

Gli ordini si intendono validi solo se confermati a mezzo fax o personalmente, ogni accordo verbale sarà declinato.

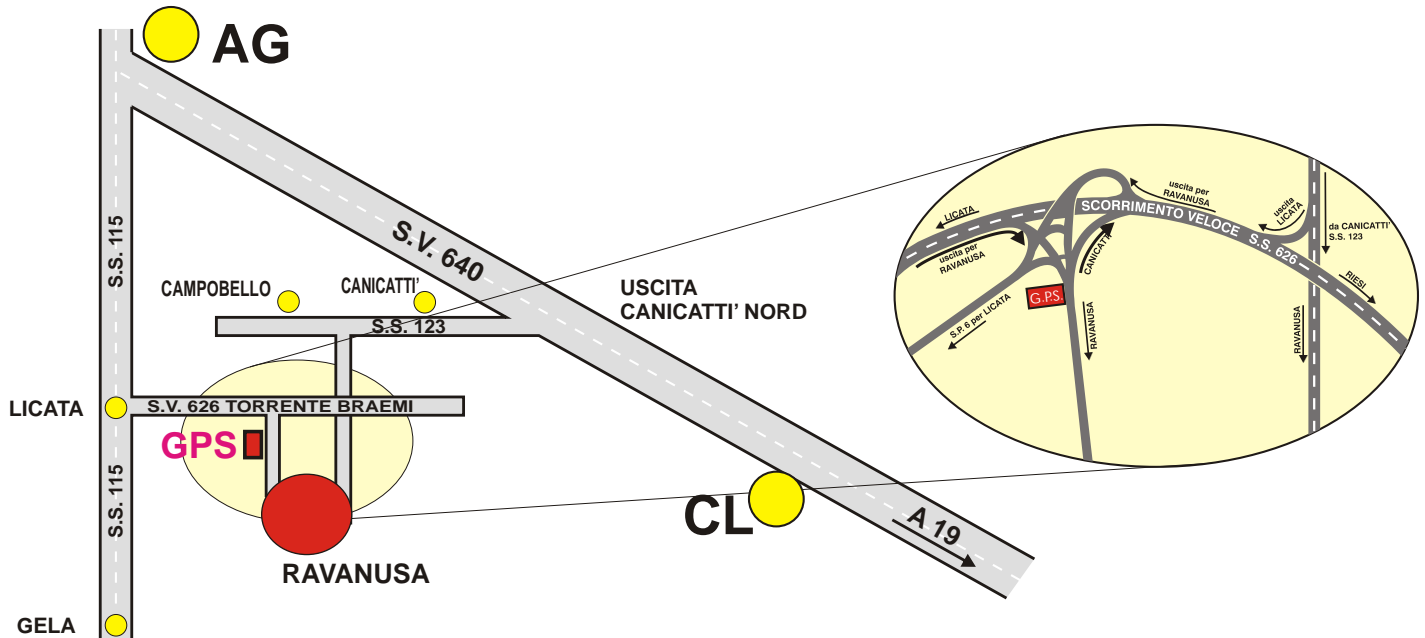

Come arrivarci:

dalla A19 PA-CT (uscita per Caltanissetta) percorrere la S.V. 640 (uscita Canicattì nord) percorrere la S.S. 123 (1ª uscita per Ravanusa)
dalla S.S. 115 (uscita per Licata) percorrere la S.V. 626 (Torrente Braemi) (l'uscita per Ravanusa)



Tip. LI PRIZZI - 328 3540874

G.P.S. di Gattuso Michele e Picone Angela & C. s.n.c.

Sede Legale Ufficio ricezione ordini - Centro di distribuzione Via Olimpica,48 - 92029 Ravanusa (AG)

Tel. +39-0922 881077 - Fax +39-0922 880080 - E-mail: info@gpsgattuso.it - Sito: www.gpsgattuso.it

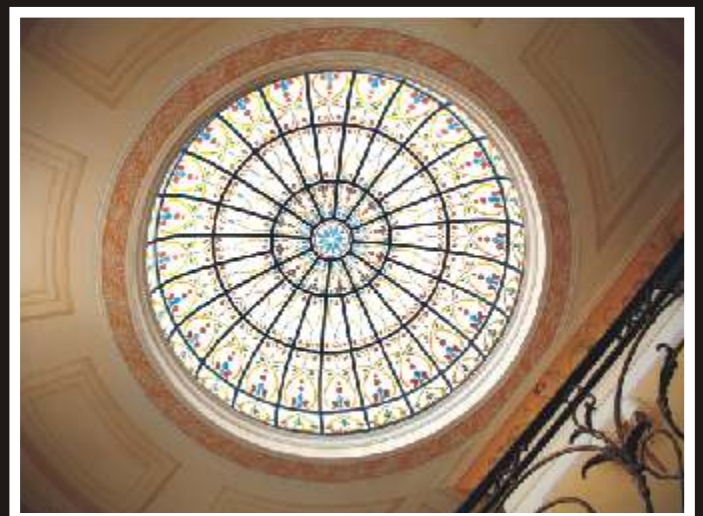

G.P.S. di Gattuso Michele e Picone Angela & C. s.n.c.
Sede Legale - Ufficio ricezione ordini - Centro di distribuzione: Via Olimpica,48 - 92029 Ravanusa (AG)
Tel. +39-0922 881077 - Fax +39-0922 880080 - E-mail: info@gpsgattuso.it - Sito: www.gpsgattuso.it